



Quality of life since 1825



Gustavsberg Export Pricelist 2024

Welcome to your new bathroom life

The life you live in your bathroom should be wonderful, refreshing, life-affirming, luxurious, encompassing and inspiring. The porcelain, mixers, furniture units, shower, bathtub and accessories must all be high-quality, with every detail carefully thought out. Everything simply has to work.

The life you live in your bathroom should also be resource-efficient. So it feels good to know that Gustavsberg has led the field in solutions that save energy, water and money since the 1970s.

This catalogue presents most of the items in our collection. You can find even more products, additional information – including manuals, instruction videos and spare parts – online at gustavsberg.com

For tips and good ideas, click the “Inspiration” tab, where you will also find our bathroom planner, which makes it simple to draw your dream bathroom and check which furniture units and other products are the best fit for the life you live in your bathroom.

Welcome!





Content

Toilets, fixtures and urnals	4
Bathroom sinks	20
Furniture	26
Mixers	56
Shower doors and walls	80
Bathtubs	90
Accessories	100
Spare parts	104
Technical drawings	116
Warranty conditions	146

Toilets, fixtures and urnals

Gustavsberg toilets are made of tightly vitrified sanitary porcelain, which is the most hygienic and durable material of all for bathroom porcelain. Our comprehensive range comprises both wall- and floor-mounted models to accommodate all wishes and needs, as well as toilets for installing in corners and small spaces. We also stock the widest range of Hygienic Flush models on the market – possibly the most hygienic type of toilet in the world.

TO THINK OF

Which model suits you best? Do you want the water trap concealed or visible? Do you prefer wall or floor-mounting? With our Triomont system you can easily install a wall hung toilet even if your current model is floor standing. Neat, comfortable and hygienic. If your home is to have two toilets, why not choose different seat heights?



HYGIENIC FLUSH

Smarter flushing for improved hygiene and easier cleaning. The innovative design with open rim and smooth surfaces eliminates all potential dirt traps. Hygienic Flush minimises the need to use strong cleaning agents.



SUPRAFIX

The patented suprafix system simplifies installation of your wall-mounted toilet and cuts installation time. Built-in wall fitting for invisible installation of wall-mounted toilets. Neater design, free from dirt traps, means improved hygiene and simpler cleaning.



CERAMICPLUS = C+

Many of our products are available with ceramicplus surface treatment. This provides the porcelain with a dirtrepellent surface that prevents the accumulation of limescale and dirt. Ceramicplus is also good for the environment, as it means that you can use a milder detergent – and less of it! – When cleaning.



NO ROOM FOR DIRT

On toilets with porcelain covers, the “seam” between the seating ring and the cover has been moved up. A soft curve in the porcelain simplifies cleaning and prevents the build-up of dirt. The foot of the toilet is smooth to facilitate cleaning and improve hygiene.



QUICK RELEASE

With quick-release functionality, you can remove the toilet seat from the bowl easily and without tools. The seat and toilet can then be cleaned separately, which is both simpler and more hygienic.



QUIET AND DRY QUIET AND DRY

The fully encompassing porcelain cistern conceals A separate inner tank. This reduces noise and counter-acts the build-up of condensation on the cistern, helping prevent the accumulation of dust.



SOFT CLOSE

Hard, solid toilet seats have previously been associated with loud noises when they are lowered. Soft close functionality has solved this problem through the introduction of a damper that is built into the seat to ensure that it can be lowered gently and quietly. The damper has no direct contact with the porcelain, which facilitates cleaning and makes the seat more hygienic.











SENSOR-CONTROLLED FLUSH

A touch-free flush function means improved hygiene. Using an app, the function can be set to flush automatically when the user walks away, or to flush at hygienic intervals if the toilet is used infrequently. Touch-free is a smart solution for all users, both at home and in public environments.



Overview flush buttons

- All flush buttons for Gustavsberg's floor mounted toilets in today's range
- Flush buttons for older / discontinued models and series of toilets can be found at www.gustavsberg.com/en/products/spareparts/

		ART No.	Price EUR VAT 0%	EAN
	<p>Flush button, dual flush</p> <p>Fits the Nautic series</p> <p>Flush button in original design. Including button housing.</p>	9GN00561	59	4051202546229
	<p>Flush button, single flush</p> <p>Fits the Nautic series</p> <p>Flush button in original design. Including button housing.</p>	9GN00661	54	4051202546137
	<p>Flush button low, dual flush</p> <p>Fits the Nautic series</p> <p>Low flush button in a stylish design that simplifies cleaning. Including button housing.</p>	9GN01161	59	4051202546182
	<p>Flush button high, red, single flush</p> <p>Fits the Nautic series</p> <p>Extra high flush button in color, especially suitable for the visually impaired and for people with reduced hand strength.</p>	9GN0133J	82	4051202844561
	<p>Flush button high, single flush</p> <p>Fits the Nautic series</p> <p>High flush button in extra durable model intended for public environments. Including button housing and custom valve.</p>	GB19299NNV36	178	7391530071633
	<p>Flush button low, chrome, dual flush</p> <p>Flush button low, matt black, dual flush</p> <p>Fits Nautic Public and Estetic series</p> <p>Low round flush button in a stylish design that simplifies cleaning. Including button housing.</p>	87569961 875698K5	31 27	4051202544591 7391530081045
	<p>Flush button low, single flush</p> <p>Fits Nautic Public and Estetic series</p> <p>Low round flush button in stainless steel. An extra durable model that withstands careless use and frequent cleaning. Primarily intended for public environments. Including button housing.</p>	9GN016D7	105	4062373887202
	<p>Flush button low, dual flush</p> <p>Fits Nordic³ series</p> <p>Low round flush button in a stylish design that simplifies cleaning. Including button housing.</p>	GB19299S3951	14	7391530066196

Floor-mounted toilet, Nautic

- Made of hygienic, durable and tightly whiterified sanitary porcelain
- Easy to clean, minimalist design
- Seat height 420 or 460 mm
- Hygienic Flush with open flush rim for easier cleaning.
- Flushes all the way up to the rim for improved hygiene
- Full-coverage, condensation-free cistern
- Quiet refilling
- Adjustable water connection for flexible installation
- Also suitable for installing in corners
- Can be fitted with armrests and care seat for functional adaptation
- Seat with Soft Close (SC) for gentle, quiet closing and Quick Release (QR) for easier cleaning
- Ceramicplus (C+) for quick, eco-friendly cleaning

		ART No.	Price EUR VAT 0%	EAN
		<p>1500 Nautic Hygienic Flush, concealed S-trap,</p> <p>White with standard seat and cover 4l White with standard seat and cover 2/4l White with SC/QR seat and cover 2/4l White w/o seat and cover 2/4l White C+ with SC/QR seat and cover 2/4l White C+ with SC/QR seat and cover 2/4l, for glueing to the floor</p> <p>Seats See page 12</p>	<p>GB111500401215 515 7391530069166 GB111500201215 532 7391530069074 GB111500201331 599 7391530067292 GB111500201205 525 7391530069067 GB1115002R1334 676 7391530067018 GB1115002R1331G 676 4051202357108</p>	
		<p>1510 Nautic Hygienic Flush, P-trap, with open flush rim</p> <p>White with standard seat and cover 4l White without seat& cover 4l White with standard seat and cover 2/4l White with SC/QR seat and cover 2/4l White w/o seat and cover 2/4l White C+ with SC/QR seat and cover 2/4l</p> <p>Seats See page 12</p>	<p>GB111510401211 515 7391530069234 GB111510401205 508 7391530067636 GB111510201215 532 7391530069180 GB111510201331 599 7391530072432 GB111510201205 525 7391530069173 GB1115102R1331 676 7391530067544</p>	
		<p>1546 Nautic Hygienic Flush, extended S-trap,</p> <p>White with standard seat and cover 4l White without seat&cover 4l White with standard seat and cover 2/4l White w/o seat and cover 2/4l</p> <p>Seats See page 12</p>	<p>GB111546401215 591 7391530069296 GB111546401205 585 7391530067476 GB111546201215 606 7391530069272 GB111546201205 599 7391530067445</p>	
		<p>1591 Nautic Hygienic Flush, S-trap and large foot, renovation model,</p> <p>White with standard seat and cover 4l With white standard seat</p> <p>Seats See page 12</p>	<p>GB111591401215 520 7391530069029 GB111591201215 539 7391530068961</p>	

Floor-mounted toilet, Public

- Durable stainless steel push button
- Made from hygienic, durable and densely sintered sanitary ware
- Easy-to-clean and minimalistic design
- Glazed under the flush edge for simplified cleaning
- Factory set single flush 4L
- Flush volume adjustable up to 6L
- Low flush button with neat design
- Seat height: 420mm
- Full-coverage, condensation-free cistern
- Quiet refilling
- Can be combined with armrest and care seat for improved accessibility
- Several seat options in two different colours, white or black
- With open, glazed flush edge for simplified cleaning
- Flushes all the way up to the rim for improved hygiene
- Ceramicplus (C+) for quick, eco-friendly cleaning
- Adjustable water connection R1/2" for flexible installation
- Floor bracket for easier installation

			ART No.	Price EUR VAT 0%	EAN
		6600 Public Hygienic Flush, concealed S-trap White C+ w/o seat and cover 4l Seats See page 12 	GB111500401215	584	7391530074955
		6610 Public Hygienic Flush, concealed P-trap with open flush rim White C+ w/o seat and cover 4l Seats See page 12 	GB1166104R1503	584	7391530074962
		6691 Public Hygienic Flush, S-trap and large foot, renovation model White C+ w/o seat and cover 4l Seats See page 12 	GB1166914R1503	579	7391530074986
		6646 Public Hygienic Flush, extended S-trap White C+ w/o seat and cover 4l Seats See page 12 	GB1166464R1503	660	7391530074979

			ART No.	Price EUR VAT 0%	EAN
		305 Nordic, children WC S-trap White with standard seat and cover 6l White with seat 6l Seats See page 12	GB1030510153 GB1030510152	511 449	7391530015569 7391530016078

Floor-mounted toilet, Estetic

- Made of hygienic, durable and tightly whiterified sanitary porcelain
- Organic design with easy-to-clean surfaces
- Hygienic Flush with open flush rim for easier cleaning
- Flushes all the way up to the rim for improved hygiene
- Factory set dual flush: 4/2 l
- Flush volume adjustable up to 6 l
- Seat height: 420 mm
- Full-coverage, condensation-free cistern
- Quiet refilling
- Two seat options: hard seat with fixed fittings, or seat with Soft Close (SC) for soft, quiet closing, and Quick Release (QR) to facilitate cleaning.
- Supplied with a flexible drain sleeve for fitting to a drain in the floor or directly into the wall
- Adjustable water connection R1/2"
- Floor connection set for quick and easy mounting
- Concealed floor connection with two screws or gluemounting to the floor
- Ceramicplus (C+) for quick, eco-friendly cleaning

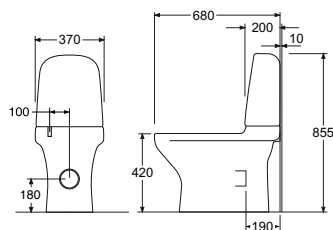

8300 Estetic, concealed S/P-trap, for screwing to the floor, with open flush rim

White C+ with SC/QR seat and cover 2/4l

Seats See page 12

8300 Estetic, concealed S/P-trap, without screw holes for gluing to the floor, with open flush rim

White C+ with SC/QR seat and cover 2/4l

Matt white C+ with SC/QR seat and cover 2/4l

Matt black C+ with SC/QR seat and cover 2/4l

Seats See page 12



ART No	Price EUR VAT 0%	EAN
GB1183002R1231	712	4051202470524
GB1183002R1231G	712	4051202483371
GB1183002RW231G	908	4051202843557
GB1183002R7231G	918	4065467454311

Floor-mounted toilet, Nordic³

- Made of hygienic, durable and tightly whiterified sanitary porcelain
- Functional design, standard dimensions
- Seat height 430 mm
- Glazed beneath the flush rim for easier cleaning
- Full-coverage, condensation-free cistern
- For installation with four screws or gluemounting to the floor
- Can be fitted with armrests and care seat for functional adaptation
- Also suitable for installing in corners

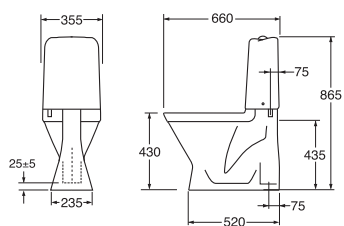

3500 Nordic³, S-trap

White with standard seat and cover 3/6l

White w/o seat and cover 3/6l

Seats See page 12



ART No	Price EUR VAT 0%	EAN
GB113500301213	402	7391530066820
GB113500301203	397	7391530066813
GB113510301213	402	7391530066844
GB113510301203	397	7391530066837

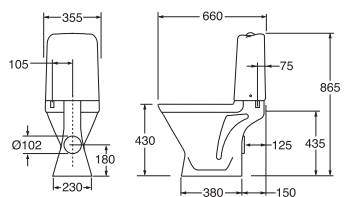

3510 Nordic³, P-trap

White with standard seat and cover 3/6l

White w/o seat and cover 3/6l

Seats See page 12



Wall-mounted toilet

- Made of hygienic, durable and tightly whiterified sanitary porcelain
- All toilets bowls can be combined with Triomont fixtures
- All Gustavsberg toilet bowls are for fitting with centre measurements of 180 or 230 mm
- Load tested to 400 kg
- Several seat options
- Seat with Soft Close (SC) for gentle, quiet closing
- Seat with Quick Release (QR) for easier cleaning
- Ceramicplus (C+) as an option for simple and eco-friendly cleaning
- Hygienic Flush with open flush rim for easier cleaning, standard on most models. Flushes all the way up to the rim for improved hygiene

		ART No.	Price EUR VAT 0%	EAN	
Nautic					
		1530 Nautic Hygienic Flush, wall hung, with open flush rim			
		White with standard seat and cover	GB111530001010	309	4062373897713
		White w/o seat and cover	GB111530001000	302	4062373897706
		White with Slimseat SC/QR	GB111530001040	388	4062373897720
		White C+ with Slimseat SC/QR	GB1115300R1040	463	4062373897751
		Seats See page 12			
Estetic					
		8330 Estetic, wall hung, Suprafix installation, with open flush rim			
		White C+ with SC/QR seat and cover	GB1183300R1030	477	4051202471927
		Matt white C+ with SC/QR seat and cover	GB1183300RW030	598	4051202843502
		Matt black C+ with SC/QR seat and cover	GB1183300R7030	598	4065467445296
		Seats See page 12			
Nordic³					
		3630 Nordic ³ Hygienic Flush, wall hung, with open flush rim			
		White with standard seat and cover	GB113630001010	193	4062373756713
		White with SC/QR seat and cover	GB113630001030	213	4062373929391
		White w/o seat and cover	GB113630001000	186	4062373759066
		Seats See page 12			
		3635 Nordic ³ Hygienic Flush, wall hung, with open flush rim, compact model			
		White with standard seat and cover	GB113635001010	217	4062373759080
		White with SC/QR seat and cover	GB113635001030	245	4062373759103
		White w/o seat and cover	GB113635001000	209	4062373759073
		Seats See page 12			
5G84					
		5G84 Hygienic Flush, wall hung, with open flush rim*			
		White with soft-close seat and cover	5G84HR01	376	4051202288662
		White w/o seat and cover	5G84R001	293	4051202288679
		Seats See page 12			
		* Delisted from 31.12.2024			

		ART No.	Price EUR VAT 0%	EAN	
Nautic with tank					
		1522 Nautic Hygienic Flush, wall hung with cistern, with open flush rim White w/o seat and cover 4l White w/o seat and cove 2/4l White C+ w/o seat and cover 2/4l	GB111522401205 GB111522201205 GB1115222R1205	570 582 658	7391530067377 7391530067346 7391530067391
		Seats See page 12			
Public with tank					
		6622 Public Hygienic Flush, wall hung with cistern, with open flush rim White C+ w/o seat and cover 4l	GB1166224R1503	634	7391530074993
		Seats See page 12			
Care					
		4G01 Care Hygienic Flush, wall hung, with open flush rim, elongated White w/o seat and cover Seats: White hard seat with fixed fittings White hard seat featuring SC/OR	4G01R001 9M676101 9M38S101	342 133 156	4051202353919 4051202452711 4051202032654
		4G95 Care Hygienic Flush, wall hung, with open flush rim White w/o seat and cover Seats: White hard seat with fixed fittings White hard seat featuring SC/OR	4G95R001 9M676101 9M38S101	317 133 156	4051202353933 4051202452711 4051202032654











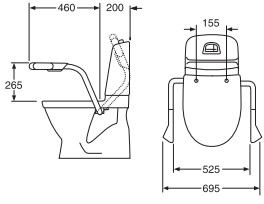

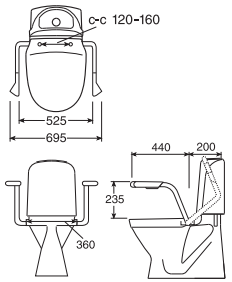

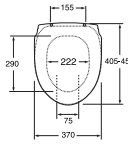

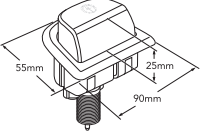
Toilets seats

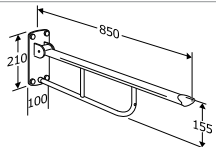
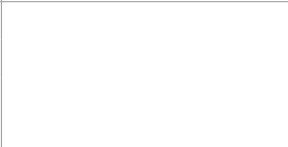
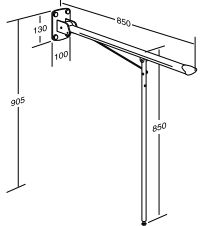
- Dimensioned to suit the different product ranges in the Gustavsberg brand
- Soft Close for quiet closing
- Quick release for simple cleaning

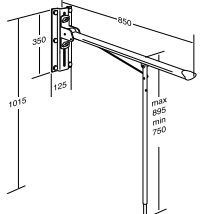
		ART No.	Price EUR VAT 0%	EAN
Toilet setas for Nautic, Nautic Hygienic Flush, Public Hygienic Flush				
		9M24 Nautic standard seat White Suits all toilets in the Nautic range	9M246101 32	4047289920007
		9M25 Nautic hard seat White with stainless steel fittings White Suits all toilets in the Nautic range	9M256101 65	4047289984108
		9M26 Nautic hard seat with SC and QR White Black Suits all toilets in the Nautic range	9M26S101 9M26S136 107 130	4047289984191 4047289984207
		8M45 Nautic Slim seat, a neater model of hart seat with SC/QR White Suits all toilets in the Nautic range	8M45S101 116	4062373839379
Toilet seats for Artic, 5G84				
		9M16 Nautic hard seat. With SC/QR White Black	9M16S101 9M16S136 156 238	4047289718109 4047289818116
Toilets seats for Estetic				
		9M10 Estetic seat for floor-mounted toilets Quick release, soft-close white Quick release, soft-close matt white Quick release, soft-close Ebony matt black Quick release, soft-close matt black	9M10S101 9M10S1RW 9M10S133 9M10S138 156 196 232 232	4051202251611 4051202843588 4065467166634 4065467445272
		9M09 Estetic seat for wall-mounted toilets Quick release, soft-close white Quick release, soft-close matt white Quick release, soft-close Ebony matt black Quick release, soft-close matt black	9M09S101 9M09S1RW 9M09S133 9M09S138 156 196 232 232	4051202251628 4051202843526 4065467166078 4065467445319
Toilets seats for Nordic³				
		8780 Nordic³ Hard seat with stainless steel fittings White	8780G101 52	4022693743008
		8780 Nordic³ Hard seat with SC White	8780S101 71	4051202349509
		9M64 Nordic³ Standard seat White	9M646101 30	4051202257101
		Nordic3 HF Compact WWC Standard Hard plastic, stainless steel hinges Quick release, soft-close	9M648101 8780G801 8780S801 34 59 80	4062373786895 4062373786871 4062373786888

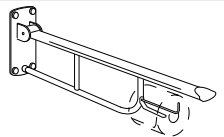

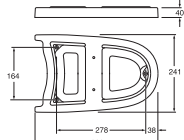







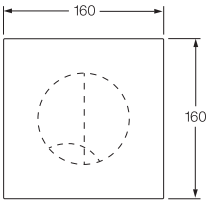





Care products – toilets











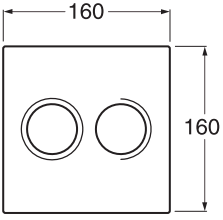

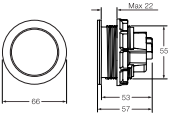

• To see products in our range that accommodate special needs, visit www.gustavsberg.com.

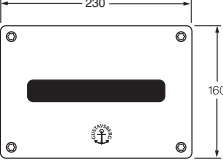
			ART No.	Price EUR VAT 0%	EAN
		<p>3055 Arm support for toilets in the Nautic range Suitable for all models in the range except 1530 and 5530</p> <p>Arm support with seat. White with dark grey handles and white seat Arm support without seat. White with dark grey handles</p> <p>3018 Toilet paper holder for arm rest</p>	GB88305501	716	5708590299570
		<p>3051 Arm support for toilets in Nordic and former Logic range</p> <p>Arm support without seat. White support with dark grey handles</p> <p>3018 Toilet paper holder for arm rest</p>	GB88305100	706	7391530064604
		<p>3060 Care seat for arm support 3055 and 3051</p> <p>Care seat, white</p> <p>Care seat, blue</p> <p>Care seat, red</p> <p>Care seat, black</p>	GB88306001	234	5708590299549
		<p>Raised single push button for Nautic WC</p> <p>Red</p>	9GN0133J	82	4051202844561
		<p>1711 Arm support for wall mounting, 1 pcs</p> <p>White</p>	GB88171101	390	7393792212205
		<p>1712 Arm support for wall mounting with leg support, 1 pcs</p> <p>White</p>	GB881712101	478	7391530067131
		<p>1713 Arm support for wall mounting, with leg support. Adjustable in height, 1 pcs</p> <p>White</p>	GB881713101	579	7393792212229
		<p>1714 Toilet paper holder for arm support 1711, 1712, 1713</p> <p>White</p>	GB88171401	70	7393792212236
		<p>Raising base</p> <p>For WC Nautic 5510, Nautic HF 1510</p>	GB8830701001	224	7391530063850

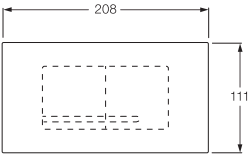
Triomont Control panels

- Numerous models and materials to choose from
 - The panel you choose determines single or dual flush
- NB The header line for the different control panels below states whether they match fixture XS or XT. Please make sure to choose a panel that matches the fixture you have ordered.

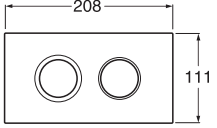
			ART No.	Price EUR VAT 0%	EAN
Wall mounted control panels single / dual flush for Triomont XS					
		White plastic, round	GB1921102035	61	8711778140783
		Matt chrome plastic, round	GB1921102036	88	8711778140790
		Bright chrome plastic, round	GB1921102037	88	8711778140806
		White plastic, single flush, round	GB1921102030	61	8711778140752
		Bright chrome plastic, single flush, round	GB1921102032	88	8711778140776
		White plastic, square	GB1921102052	61	8711778168749
		Bright chrome plastic, square	GB1921102053	88	8711778168756
		White metal, square	GB1921102045	279	8711778140691
		Bright chrome metal, square	GB1921102047	262	8711778140714
		Matt black plastic, square	GB1921102049	90	4062373904107
		Stainless, rectangular	GB1921102054	262	8711778170933
		White glass, rectangular	GB1921102056	525	4051202796914
		Black glass, rectangular	GB1921102057	525	4051202796532
		Aluminium, rectangular	GB1921102058	392	4051202796549
	Matt black aluminium, square	GB1921102048	397	4062373888421	

		ART No.	Price EUR VAT 0%	EAN	
Pneumatic wall mounted control panels dual flush for Triomont XS					
		White plastic	GB1921102060	102	8711778169579
		Bright chrome plastic	GB1921102061	132	8711778169586
		White glass	GB1921102066	314	8711778169630
		Black glass p	GB1921102067	314	8711778169647
Pneumatic button, single flush, fits all fixture models					
	 <p>Stainless</p> <p> <i>Make sure to install some kind of inspection hatch to reach the valves in the built-in-cistern, when choosing a pneumatic button.</i></p>	GB1921102092	139	8711778169920	
Sensor controlled *) wall mounted control panels for Triomont XS					
		White, dual flush	GB1921102070	660	4051202796907
		Stainless, dual flush. Mainly for public settings *) Always complete sensor controlled panels with: <i>Battery box</i> <i>AC adapter</i> <i>Plug-in adapter</i>	GB1921102071	1035	4051202796594
		<i>Battery box</i>	GB1921102077	91	4051202796921
		<i>AC adapter</i>	GB1921102078	159	4051202796945
	<i>Plug-in adapter</i>	GB1921102079	139	4051202796938	
Top mounted control panels, dual flush for Triomont XT					
		White plastic, rectangular	GB1921102080	57	8711778168626
		Bright chrome plastic, rectangular	GB1921102081	88	8711778168640
		Black glass, rectangular	GB1921102083	500	8711778215740
Pneumatic top mounted control panels, dual flush for Triomont XT					
		White plastic	GB1921102085	102	8711778169470
		Bright chrome plastic	GB1921102086	132	8711778169487

Triomont toilet fixture

- Neat installation with a minimum of visible pipes
- Wide range of control panels in a variety of styles
- Choose high or low flush volume
- We supply the widest range of wall-mounted toilet bowls on the market
- Adjustable flush volume – see installation instructions supplied
- Space-efficient design, just 380 mm wide
- Wall fittings included. No need to drill holes in the floor
- Rotatable wall fittings for a flexible wall connection
- Sitting height 410–630 mm. Recommended sitting height, 450 mm above the floor
- Floor- or wall-connected drain
- Load tested steel frame to 400 kg
- Fixture in line with SS 820200 standard
- Cistern in line with EN 14055
- Suitable for AMA installation without extra components (SE)

		ART No.	Price EUR VAT 0%	EAN
		<p>Triomont XS fixture for wall-mounted or pneumatic control panel High model for fitting against a straight wall or in a corner. Add a control panel and wall-mounted toilet to complete. The control panel determines the type of flush.</p> <p>Triomont XS, dual flush 4.5/3-litre or single flush 4.5-litre</p> <p>Triomont XS, dual flush 6/3-litre or single flush 6-litre</p> <p>Accessories</p> <p>Corner fitting for corner installation</p> <p>Extra wall fitting (when the lower fitting supplied cannot be used).</p> <p>Installation: The height on the sketch (1000 mm) results in a toilet seat height of 410-430 mm, depending on toilet model. On installation, this can be adjusted up to 610-630 mm. Weight: 14 kg including packaging.</p>	<p>GBI921102026 435 8711778215757</p> <p>GBI921102020 418 8711778140813</p> <p>GBI921102029 49 8711778140837</p> <p>GBI921102027 67 8711778140820</p>	
		<p>Triomont XT fixture for top-mounted or pneumatic control panel Low model for fitting against a straight wall. Add a control panel and wall-mounted toilet to complete. The control panel determines the type of flush.</p> <p>Triomont XT, dual flush 6/3-litre or single flush 6-litre</p> <p>Accessories</p> <p>Extra wall fitting (when the lower fitting supplied cannot be used)</p> <p>Installation: The height on the sketch (830 mm) results in a toilet seat height of 410-430 mm depending on toilet model. On installation, this can be adjusted up to 610-630 mm. Weight: 12 kg including packaging.</p>	<p>GBI921102024 402 8711778169067</p> <p>GBI921102027 67 8711778140820</p>	
		<p>Triomont XS Vario fixture for wall-mounted or pneumatic control panel Primarily intended for hospitals and care homes. High model for fitting against a straight wall or in a corner. With adjustable sitting height after installation. Add a control panel and wall-mounted toilet to complete. The control panel determines the type of flush.</p> <p>Triomont XS Vario, dual flush 6/3-litre or single flush 6-litre.</p> <p>Accessories</p> <p>Corner fitting for corner installation</p> <p>Extra wall fitting (when the lower fitting supplied cannot be used)</p> <p>Installation: The height on the sketch (1000 mm) results in a toilet seat height of 410-430 mm, depending on toilet model. On installation, this can be adjusted up to 610-630 mm. After installation, the toilet can be raised 100 mm. It can naturally also be returned to its original position. Weight: 19 kg including packaging.</p>	<p>GBI921102022 912 8711778169715</p> <p>GBI921102029 49 8711778140837</p> <p>GBI921102027 67 8711778140820</p>	

Triomont toilet fixture deliveries include:

- Fixture with four wall fittings
- Complete cistern insulated against condensation, with flush fitting and shut-off valve
- Connection components for drain and water supply (pipe in pipe)
- Hole template for button

- M12 threaded bars for fitting the toilet.
- Protection plugs
- Screws and plugs for fixing
- Insulation protection for fitting between the porcelain and the wall
- Drilling template for wall
- Installation instructions

- Always finish off with:*
- Wall-mounted toilet
 - Control panel

Triomont toilet fixture All-in-one

- Neat installation with a minimum of visible pipes
- Toilet, fixture and control panel all included in the package
- Hygienic Flush with open flush rim for easier cleaning. Flushes all the way up to the rim for improved hygiene
- Quick and easy to install with Suprafix, where the entire toilet is fitted through the holes for the seat; no visible screws = Estetic model
- Adjustable flush volume – see installation instructions supplied
- Space-efficient design, just 380 mm wide
- Wall fittings included. No need to drill holes in the floor
- Rotatable wall fittings for a flexible wall connection
- Sitting height 410–630 mm. Recommended sitting height, 450 mm above the floor
- Floor- or wall-connected drain
- Load tested steel frame to 400 kg
- Fixture in line with SS 820200 standard
- Cistern in line with EN 14055
- Suitable for AMA installation without extra components (SE)

		ART No.	Price EUR VAT 0%	EAN
		Triomont XS fixture, including Nautic toilet and control panel High model for fitting against a straight wall or in a corner. Complete package including control panel for dual flush (GB1921102052) and Nautic toilet (GB111530001040) with hidden fixation. The Toilet features Hygienic flush for improved hygiene and Slim seat with SC/QR.		
		Triomont XS, dual flush 4.5/3-litre including Nautic toilet Accessories Corner fitting for corner installation		
		GB1921102202	801	7391530082684
		GB1921102029	49	8711778140837
		Triomont XS fixture, including Estetic toilet and control panel High model for fitting against a straight wall or in a corner. Complete package including pneumatic control panel for dual flush 4.5/3 liters (GB1921102052) and Estetic toilet (GB1183300R1030). The Toilet features Hygienic flush for improved hygiene and Suprafix for quick and easy installation.		
		Triomont XS, dual flush 4.5/3-litre including Estetic toilet Accessories Corner fitting for corner installation		
		GB1921102201	952	4062373792346
		GB1921102029	49	8711778140837
		Triomont XS fixture, including Nordic³ toilet and control panel High model for fitting against a straight wall or in a corner. Complete package including control panel for dual flush 4.5/3 liters (GB1921192935) and Nordic ³ HF toilet (GB11363001030). The Toilet features Hygienic flush for improved hygiene.		
		Triomont XS, dual flush 4.5/3-litre including Nordic ³ HF toilet Accessories Corner fitting for corner installation <i>Make sure to install some kind of inspection hatch to reach the valves in the built-in-cistern, when choosing a pneumatic button.</i>		
		GB1921102203	668	8711778226340
		GB1921102029	49	8711778140837

Triomont installation system for wallhung toilets with visible cistern

- Neat installation, with a minimum of visible pipes
- Load-tested 400 kg
- Floor or wall-connected drain
- Fits all wall-hung toilets with a centre to centre distance between bolts of 180 or 230 mm
- Recommended seat height, 450 mm

		ART No.	Price EUR VAT 0%	EAN
		Triomont fixture for wallhung toilets with visible water cistern For mounting against straight wall or in a corner		
		Accessories Corner fitting for corner installation Extra wall fitting (when the lower fixture supplied cannot be used). Weight: 9 kg including packaging		
		GB19211000510	243	8711778182844
		GB1921102029	49	8711778140837
		GB1921102027	67	8711778140820

Triomont toilet fixture deliverie include:

- Fixture with four wall fittings
- M12 threaded bars for fitting the toilet bowl.
- Screws and plugs for fixing.

- Installation instructions.
- Connecting components for wall alt. floor connection
- Suitable toilet

Always finish off with:

Urinals

- Fits in public places as well as in the private home. Contact us for more information about installing our urinals.
- Finish of with flushing device and captive waste to complete

		ART No.	Price EUR VAT 0%	EAN	
		<p>7G50 Saval top water inlet urinal With open water connection for mounting with visible plumbing. Water trap as separate order.</p> <p>Accessories</p> <p>Water trap for wall connection</p> <p>Water trap for floor connection</p> <p>Water connector seal</p>	7G500001	189	4022693744388
		<p>7G51 Saval concealed water inlet urinal With covered water connection for mounting with concealed plumbing. Water trap and connector nipple as separate order.</p> <p>Accessories</p> <p>Water trap for wall connection</p> <p>Water trap for floor connection</p> <p>Water connector seal</p>	7G510001	192	4022693742438
		Water trap for wall connection	93260000	37	4047289529392
		Water trap for floor connection	93270000	37	4047289529385
		Water connector seal	99330000	39	4005176160776

The advantages of porcelain



"Genuine vitreous china"

Simply means tightly vitrified sanitary porcelain, the most hygienic and durable material of all for bathroom porcelain. It provides a strong, resistant surface that stands every day use, year after year.

Hygienic

The surface provides a hard and tight surface that makes it withstand scratching, easy to keep clean and is therefore hygienic.



Ceramic plus

Many of our products are available with ceramicplus surface treatment. This provides the porcelain with a dirtrepellent surface that prevents the accumulation of limescale and dirt. Ceramicplus is also good for the environment, as it means that you can use a milder detergent – and less of it!



Persistent

High resistance to the chemicals found in, for example, cosmetics, styling products and other things that are common in the bathroom. Not even nail polish leaves any marks on the porcelain surface.

Hygienic flush

Smarter flushing for improved hygiene and easier cleaning. The innovative design with open rim and smooth surfaces eliminates all potential dirt traps. Hygienic flush minimizes the need to use strong cleaning agents.



Bathroom sinks

A good washbasin must be functional, easy to clean and hard-wearing – but also neat and attractive. Only porcelain of the highest quality – as used in washbasins from Gustavsberg – can meet all these requirements. Big bathroom? Small bathroom? Corner, elongated surfaces or tight space? No matter what your bathroom looks like, we can almost guarantee that you will find a Gustavsberg washbasin to match it. Don't forget to check out our washstands with full-cover washbasins, which you will find under our furniture collection. One of these may well be an even better solution for your bathroom.

THINGS TO THINK ABOUT

Large bathrooms have plenty of room to install two generous washbasins so as to eliminate the problem of morning queues. Small bathrooms, however, sometimes barely have space for a single basin. In this case, what you need is a smaller model or one designed for positioning in a corner. Whatever your situation, you are sure to find the right washbasin at Gustavsberg. It may also be useful to consider laying out your bathroom with an eye to the future – when you may not be as mobile as you once were. Our broad collection also contains a number of washbasins for special needs.



CERAMICPLUS = C+

Many of our products are available with ceramicplus surface treatment. This provides the porcelain with a dirtrepellent surface that prevents the accumulation of limescale and dirt. Ceramicplus is also good for the environment, as it means that you can use a milder detergent – and less of it! – When cleaning.



FLEXIBLE BOLT SPACING

Flexible bolt spacing makes it possible to replace your existing wall-mounted washbasin with a new model, regardless of whether the distance between the bolts on the wall is 280 or 350 mm.



Bathroom sink Nautic

- Easy-to-clean, minimalistic design in a range of sizes, 40–60 cm
- Elliptical basin with generous flat surfaces
- For bolt or bracket installation
- C+ as an option for simple and eco-friendly cleaning
- Mixer and bottom valve are not included, must be ordered separately. See mixer section

		ART No.	Price EUR VAT 0%	EAN	
		5540 Nautic for bolt mounting. 400x275 mm, bolts included			
		White with tap hole on the right			55409R01 87 4047289973362
		White with tap hole on the left			55409L01 87 4047289973324
		5540 Nautic for bolt mounting. 400x275 mm, with C+, bolts included			
		White with tap hole on the right			55409RR1 150 4047289973379
		White with tap hole on the left			55409LR1 150 4047289973331
		5550 Nautic for bolt and bracket mounting*. 500x380 mm			
		White with tap hole			55509901 4047289917496
		White without tap hole			55509701 93 4047289917458
		5550 Nautic for bolt and bracket mounting*. 500x380 mm, with C+			
		White with tap hole			555099R1 161 4047289917502
		White C+ without tap hole			555097R1 161 4047289917465
		5556 Nautic for bolt and bracket mounting*. 560x430 mm			
		White with tap hole			55569901 93 4047289917410
		White without tap hole			55569701 93 4047289917380
		White with tap hole, without overflow**			55569801 93 4047289917397
		5556 Nautic for bolt and bracket mounting*. 560x430 mm, with C+			
		White with tap hole			555699R1 161 4047289917427
		White without tap hole			555697R1 161 4047289917373
		White with tap hole, without overflow**			555698R1 161 4047289917403
		* Recommended bracket length 260 mm			
		** Mounting with strainer valve recommended			
		C+			
				5560 Nautic for bolt and bracket mounting*. 600x460 mm	
White with tap hole				55609901 102 4047289917571	
White without tap hole				55609701 102 4047289917533	
White with tap hole, without overflow**				55609801 102 4047289917557	
5560 Nautic for bolt and bracket mounting*. 600x460 mm, with C+					
White with tap hole				556099R1 175 4047289917588	
White without tap hole				556097R1 175 4047289917540	
White with tap hole, without overflow**				556098R1 175 4047289917564	
* Recommended bracket length 260 mm					
** Mounting with strainer valve recommended					
C+					

Bathroom sink Artic Small

- Small model suitable for small bathrooms
- Artic small in matt black and matt white fits with Estetic toilets in the same colour
- Made of hygienic, durable and tightly vitrified sanitary porcelain
- For bolt installation

		ART No.	Price EUR VAT 0%	EAN	
		4G36 Artic Small for bolt mounting, 360x220 mm. With basin to the left			
		White	4G369L01	175	4062373909805
		Matt white	4G369LSW	243	4065467455516
		Matt black	4G369L38	270	4065467445234
		4G36 Artic Small for bolt mounting, 360x220 mm. With basin to the right			
		White	4G369R01	175	4062373909829
		Matt white	4G369RSW	243	4065467455509
		Matt black	4G369R38	270	4065467445227

Bathroom sink Nordic³

- Made of hygienic, durable and tightly vitrified sanitary porcelain
- Functional design, standard dimensions
- For bolt or bracket installation

		ART No.	Price EUR VAT 0%	EAN
		410050 Nordic3 for bolt or bracket mounting, 500x370 mm		
		White with tap hole	41005001	80
		Recommended bracket length 195 or 240 mm		
		410055 Nordic3, for bolt or bracket mounting, 550x435 mm		
		White with tap hole	41005501	93
		Recommended bracket length 260 mm		

Bathroom sink complementary model











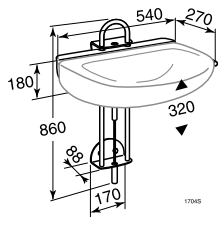

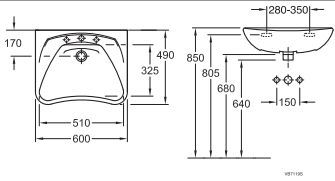

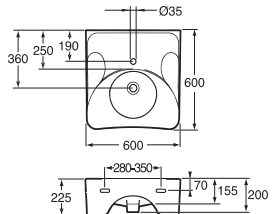

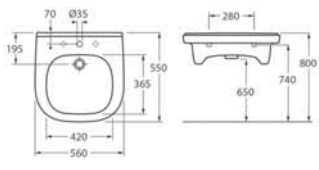
- Models that do not belong to any of our product collections, but match all ranges
- Mixer and bottom valve are not included, must be ordered separately. See mixer section

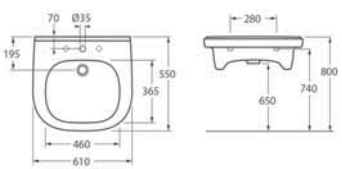
		ART No.	Price EUR VAT 0%	EAN
		7327-98, 415x555mm Bolt mounting corner hand washbasin		
		White with tap hole	GB1573279801	224
		2560, 560*415mm bolt or bracket mounting (240mm)*		
		White with tap hole	GB1125600101	96
		*Delisted from 31.12.2024		

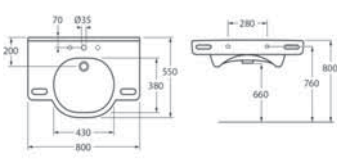
Bathroom sinks

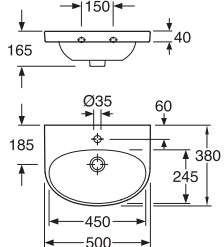
Care

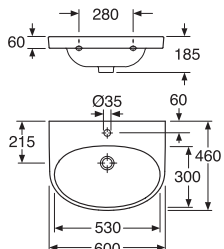
• To view other products for special needs, visit www.gustavsberg.com

		ART No.	Price EUR VAT 0%	EAN
		1704, washbasin lifter with built-in gas cylinder, fits washbasin with max. width 640 mm, height adjustment 315 mm, lever control can be adjust to right or left Metal 1708 Flexible hose set *Washbasins, mixers and hoses are not included 	GB88170401 1493 GB88170801 221	7393792212137 7393792212175
		7119-63 for bolt mounting, with overflow and bottom valve, tap hole in the center, 600x490 mm White 	GB157119630110 246	7391530059648
		740 for bolt mounting, tap hole in the center, 600x600 mm Suitable with washbasin lifter 1704. Extra shallow basin to accommodate wheelchair users. White w/o overflow White with tap hole, with overflow outlet 	GB1074010102 470 GB1074010101 470	7391530038407 7391530038391
		4G19 55 for bolt mounting, 560x550 mm with grabbing edge, tap hole in the center* White with overflow *Delisted from 31.12.2024	4G195501 252	4051202473792
		4G19 60 for bolt mounting, 610x550 mm with grabbing edge, tap hole in the center* White w/o overflow White with overflow *Delisted from 31.12.2024	4G196101 263 4G196001 263	4051202348564 4051202348588
		4G20 80 for bolt mounting 800x550 mm with grabbing edge, tap hole in the center* White with overflow *Delisted from 31.12.2024	4G208001 532	4051202348540
		5550 Nautic Care, bolt or bracket mounting (195mm or 260mm), 500x380 mm, with C+ White w/o overflow White w/o overflow, w/o taphole 	555061R1 223 55506MR1 223	4062373907221 4062373907498
		5560 Nautic Care, bolt or bracket mounting (260 mm), 600x460 mm, with C+ White w/o overflow White w/o overflow 	556061R1 251 55606MR1 251	4062373907214 4062373907504

Furniture

A bathroom needs to be functional and practical for everyone in the family. It should also serve as a tranquil oasis to which you can retire to recuperate after a demanding day. Both form and function should invite you in for a sweet and simple sojourn in the bathroom.

Bathroom furniture from Gustavsberg features timeless Scandinavian design and maintains a superior level of quality. All materials have been tested to ensure they can withstand the humid environment of a bathroom in use. Our unique spare parts guarantee and complementary products ensure that you and our products can live a long life together. The only question is:

ARE YOU TEAM ARTIC OR TEAM GRAPHIC?

Artic is a range of furniture for the more spacious bathroom, making it easy to furnish the room with elevated design and a superior sense of quality. The units are “pure Scandinavian” in their design idiom, with the emphasis on straight lines and right angles. Artic is available in white, peach, black ash veneer and ash grey. The counter top washbasins are available in glossy white, matt white or matt black glaze.

Graphic, too, radiates Scandinavian quality and feeling for form, but the focus here is on maximum storage in minimum space. The furniture units are neat and compact, based on modules that it is simple to combine. Graphic is available in white, grey, green and beige. The counter top washbasins in the Graphic series is always in glossy white.

THINGS TO THINK ABOUT

Gustavsberg furniture units are built to withstand the ravages of time, but don't forget that both your own life and your bathroom-related needs may change over the years. You will never regret investing in quality and smart storage solutions.



SOFT CLOSE FURNITURE

If the acoustics in a bathroom can result in loud, sudden noises being particularly irritating. With soft-close functionality, cabinet doors and drawers close gently and quietly.



MOISTURE RESISTANT

The wood used in Gustavsberg bathroom furniture has been developed and tested for high durability in hot, humid bathroom environments. Smart design – e.g. The way our washbasins extend beyond the edge of our washbasins – protects the furniture from splashes and eliminates unnecessary moisture traps.



Artic bathroom furniture

Artic's timeless design makes all bathrooms more beautiful. Although Artic is a cultured range, the cabinets can easily 'swallow' everything you need to keep in a bathroom.

The units are based on standard dimensions and feature generous storage areas and surface space, as well as a host of smart details.

Cabinet doors and frames of the same colour create a harmonious bathroom.

Mirror cabinet

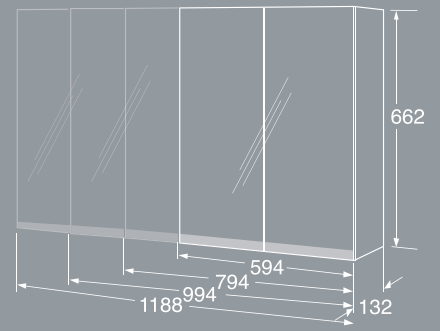

Wahsbasin colours



Glossy white



Matt white



Matt black

Bathroom cabinet with sink

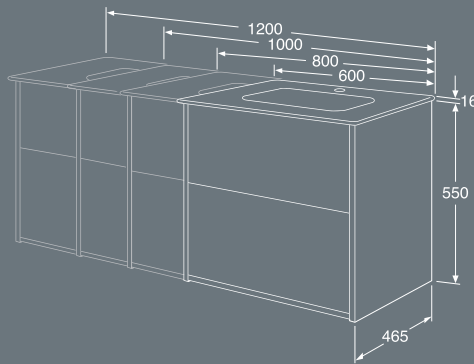

Wall cabinet

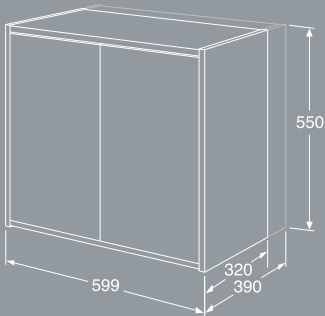

Furniture colours



White



Ash grey



Black ash wood

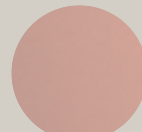

Peach

High cabinet

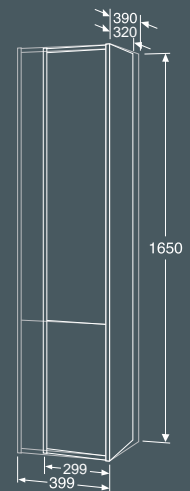

HANDLES AND KNOBS

All handles and knobs fit all our bathroom furniture units. Several of the knobs can also be mounted on walls as towel hooks.

Mirrors and lighting for mirrors and mirror cabinets



Artic bathroom cabinet with sink

- Installation system that makes it quick and easy to fit and adjust the units
- Soft-close drawers for soft and silent closing.
- Drawers with full-length pull-out provide a complete overview of all bits and bobs
- Available in different colours, with washbasins in glossy white, matt white or matt black
- Same material and colour on the cabinet frame, doors and drawers
- With space to run pipes behind the drawers
- Full-cover porcelain sink in slim design with generous surfaces
- Made of bathroom-class material for humid environments
- Simple, easy-to-clean water trap with pop-up function included
- Electrical socket and drawer lighting available as extras
- A variety of handles in different styles are available as extras
- Also available with handle-free push open function

Colour

ART No.

Price EUR
VAT 0%

EAN

Width 600 mm with glossy white or matt white sink

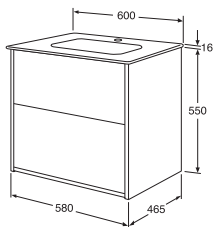

White – glossy white sink	GB71ACVU60TM01	1202	4065467174974
White – matt white sink	GB71ACVU60TMSW	1247	4065467455851
Black ash wood – glossy white sink	GB71ACVU60TK01	1588	4065467175179
Black ash wood – matt white sink	GB71ACVU60TKSW	1633	4065467456155
Ash grey – glossy white sink	GB71ACVU60TLO1	1202	4065467175124
Ash grey – matt white sink	GB71ACVU60TLSW	1247	4065467456100
Peach – glossy white sink	GB71ACVU60TO01	1202	4065467175223
Peach – matt white sink	GB71ACVU60TOSW	1247	4065467456209

Width 600 mm with matt black sink

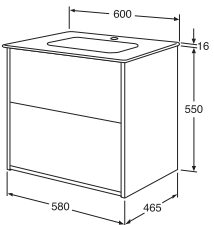

White	GB71ACVU60TM33	1247	4065467175278
Black ash wood	GB71ACVU60TK33	1633	4065467175377
Ash grey	GB71ACVU60TL33	1247	4065467175322
Peach	GB71ACVU60TO33	1247	4065467175421



Drawer insert, 600 mm; fits the bottom drawer only	GB7199DRBL60	131	7391530079196
--	--------------	-----	---------------



Push-open function for 600 mm drawer; order 1 per drawer	GB7199PU60	166	7391530079042
--	------------	-----	---------------

Width 800 mm with glossy white or matt white sink

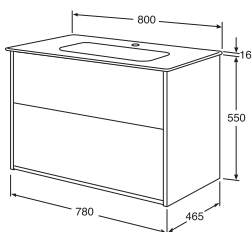

White – glossy white sink	GB71ACVU80TM01	1414	4065467174981
White – matt white sink	GB71ACVU80TMSW	1484	4065467455868
Black ash wood – glossy white sink	GB71ACVU80TK01	1826	4065467175186
Black ash wood – matt white sink	GB71ACVU80TKSW	1896	4065467456162
Ash grey – glossy white sink	GB71ACVU80TLO1	1414	4065467175131
Ash grey – matt white sink	GB71ACVU80TLSW	1484	4065467456117
Peach – glossy white sink	GB71ACVU80TO01	1414	4065467175230
Peach – matt white sink	GB71ACVU80TOSW	1484	4065467456216

Width 800 mm with matt black sink

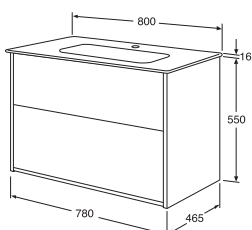

White	GB71ACVU80TM33	1484	4065467175285
Black ash wood	GB71ACVU80TK33	1896	4065467175384
Ash grey	GB71ACVU80TL33	1484	4065467175339
Peach	GB71ACVU80TO33	1484	4065467175438

Colour

ART No. Price EUR
VAT 0%

EAN

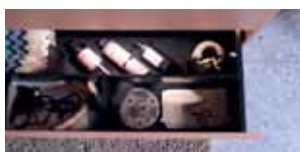

Drawer insert, 800 mm;
fits the bottom drawer
only

GB7199DRBL80

204

7391530079202



Push-open function for
800 mm
drawer; order 1 per drawer

GB7199PU80

186

7391530079059

Width 1000 mm with glossy white or matt white sink

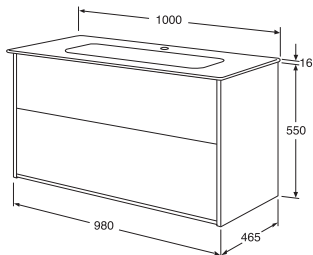

White – glossy white sink	GB71ACVU10TM011	1490	4065467174998
White – matt white sink	GB71ACVU10TMSW1	1563	4065467455875
Black ash wood – glossy white sink	GB71ACVU10TK011	1928	4065467175193
Black ash wood – matt white sink	GB71ACVU10TKSW1	2001	4065467456179
Ash grey – glossy white sink	GB71ACVU10TL011	1490	4065467175148
Ash grey – matt white sink	GB71ACVU10TLSW1	1563	4065467456124
Peach – glossy white sink	GB71ACVU10T0011	1490	4065467175247
Peach – matt white sink	GB71ACVU10TOSW1	1563	4065467456223



Width 1000 mm with matt black sink

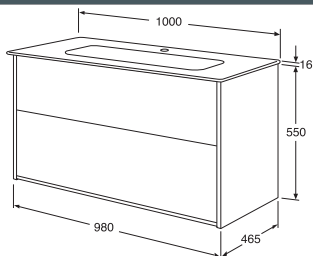

White	GB71ACVU10TM331	1563	4065467175292
Black ash wood	GB71ACVU10TK331	2001	4065467175391
Ash grey	GB71ACVU10TL331	1563	4065467175346
Peach	GB71ACVU10T0331	1563	4065467175445



Drawer insert, 1000 mm;
fits the bottom drawer
only

GB7199DRBL10

204

7391530079219



Push-open function for
1000 mm drawer; order 1
per drawer

GB7199PU10

186

7391530079066

Width 1000 mm with glossy white or matt white sink, two mixer holes

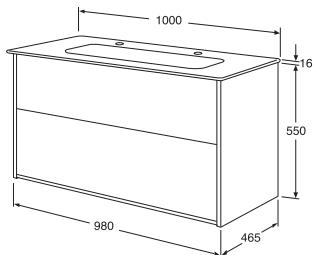

White – glossy white sink	GB71ACVU10TM012	1490	4065467175100
White – matt white sink	GB71ACVU10TMSW2	1563	4065467455882
Black ash wood – glossy white sink	GB71ACVU10TK012	1928	4065467175100
Black ash wood – matt white sink	GB71ACVU10TKSW2	2001	4065467456186
Ash grey – glossy white sink	GB71ACVU10TL012	1490	4065467175155
Ash grey – matt white sink	GB71ACVU10TLSW2	1563	4065467456131
Peach – glossy white sink	GB71ACVU10T0012	1490	4065467175254
Peach – matt white sink	GB71ACVU10TOSW2	1563	4065467456230



Colour

ART No. Price EUR
VAT 0%

EAN

Width 1000 mm with matt black sink, two mixer holes

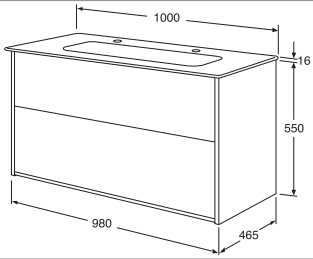

White	GB71ACVUI0TM332	1563	4065467175308
Black ash wood	GB71ACVUI0TK332	2001	4065467175407
Ash grey	GB71ACVUI0TL332	1563	4065467175353
Peach	GB71ACVUI0T0332	1563	4065467175452



Drawer insert, 1000 mm;
fits the bottom drawer
only

GB7199DRBL10

204

7391530079219



Push-open function for
1000 mm drawer; order 1
per drawer

GB7199PU10

186

7391530079066

Width 1200 mm with glossy white or matt white sink, two mixer holes

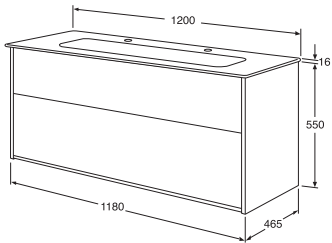

White – glossy white sink	GB71ACVUI2TM01	1560	4065467175117
White – matt white sink	GB71ACVUI2TMSW	1636	4065467455899
Black ash wood – glossy white sink	GB71ACVUI2TK01	2016	4065467175216
Black ash wood – matt white sink	GB71ACVUI2TKSW	2093	4065467456193
Ash grey – glossy white sink	GB71ACVUI2TL01	1560	4065467175162
Ash grey – matt white sink	GB71ACVUI2TLSW	1636	4065467456148
Peach – glossy white sink	GB71ACVUI2T001	1560	4065467175261
Peach – matt white sink	GB71ACVUI2T0SW	1636	4065467456247



Width 1200 mm with matt black sink, two mixer holes

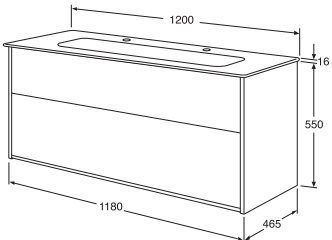

White	GB71ACVUI2TM33	1636	4065467175315
Black ash wood	GB71ACVUI2TK33	2093	4065467175414
Ash grey	GB71ACVUI2TL33	1636	4065467175360
Peach	GB71ACVUI2T033	1636	4065467175469



Drawer insert, 1200 mm;
fits the bottom drawer
only

GB7199DRBL12

204

7391530079226



Push-open function
for 1200 mm drawer;
order 1 per drawer

GB7199PU12

186

7391530079073

Leg frame with adjustable feet

- Provides a more "furnished" feel in the bathroom, available in white or black
- Leg frame for bathroom cabinet (the cabinet must always be fixed to the wall)

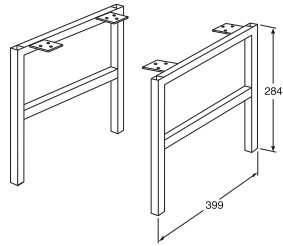

Colour

ART No.

Price EUR
VAT 0%

EAN

White

GB71ACLFVUWM

257

4065467172062

Matt black

GB71ACLFVUBL

242

4065467172079

Alternative plug for bottom valve



Matte black plug for bottom valve (for replacing the chromed version supplied)

GB7199ACPOPBL

99

6416931010515

Artic mirror cabinet

- Double-sided soft-closing mirror doors
- Integrated electrical socket inside the cabinet
- Frosted edges at the bottom of the mirror prevent smudges
- Knick-knack magnet and magnifying mirror included, for positioning as required
- LED lighting under the cabinet
- Converter included
- 2 x movable glass shelves
- For installation in area 2 in the bathroom
- Encapsulation class IP44
- Intended for fixed installation on wall
- The electrical installation must be performed by an authorised electrician
- Installation system, quick and easy to fit on the wall
- Bathroom-class particle board for humid environments

Colour

ART No. Price EUR
VAT 0%

EAN

Width 600 mm

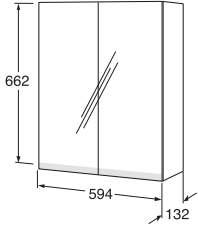

White	GB71ACMC60TM	1159	4065467171768
Black ash wood	GB71ACMC60TK	1274	4065467171829
Ash grey	GB71ACMC60TL	1159	4065467171799
Peach	GB71ACMC60TO	1159	4065467171850



Width 800 mm

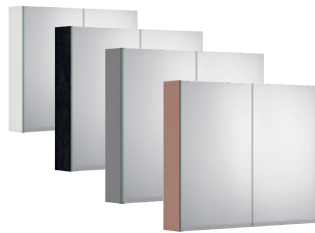
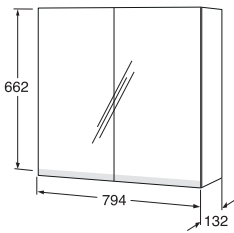

White	GB71ACMC80TM	1205	4065467171775
Black ash wood	GB71ACMC80TK	1325	4065467171836
Ash grey	GB71ACMC80TL	1205	4065467171805
Peach	GB71ACMC80TO	1205	4065467171867



Width 1000 mm

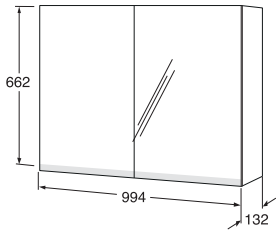

White	GB71ACMC10TM	1271	4065467171782
Black ash wood	GB71ACMC10TK	1398	4065467171843
Ash grey	GB71ACMC10TL	1271	4065467171812
Peach	GB71ACMC10TO	1271	4065467171874



Width 1200 mm (consists of 2 x 600 mm cabinets)

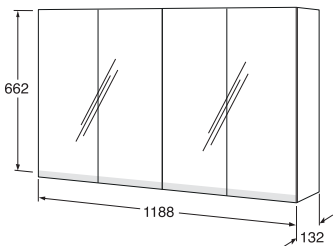

White	GB71ACMC12TM	2317	4065467175476
Black ash wood	GB71ACMC12TK	2548	4065467175490
Ash grey	GB71ACMC12TL	2317	4065467175483
Peach	GB71ACMC12TO	2317	4065467175506



Artic wall cabinet

- Soft-close doors
- Two movable glass shelves
- Can be fitted as a top cabinet or on a leg frame to create a more furnished look in the bathroom
- Available in two depths: 32 cm and 39 cm
- Same material and colour on the cabinet frame and door
- Installation system for quick and easy fitting on the wall
- A variety of handles in different styles are available as extras
- Made of bathroom-class material for humid environments

Colour

ART No. Price EUR
VAT 0%

EAN

Width 600 mm, depth 390 mm

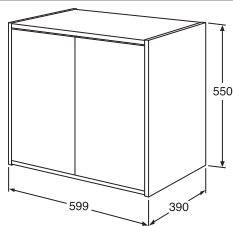

White	GB71ACSC6039TM	592	4065467172000
Black ash wood	GB71ACSC6039TK	722	4065467172024
Ash grey	GB71ACSC6039TL	592	4065467172017
Peach	GB71ACSC6039TO	592	4065467172031



Width 600 mm, depth 320 mm

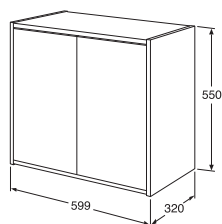

White	GB71ACSC6032TM	562	4065467171966
Black ash wood	GB71ACSC6032TK	685	4065467171980
Ash grey	GB71ACSC6032TL	562	4065467171973
Peach	GB71ACSC6032TO	562	4065467171997



Artic high cabinet

- Soft-close doors
- Reversible doors for right- or left-hand installation
- One fixed wooden shelf and four movable glass shelves
- Can be fitted as a top cabinet or on a leg frame to create a more furnished look in the bathroom
- Same material and colour on the cabinet frame and door
- With smart storage on the inside of the upper door
- Installation system for quick and easy fitting on the wall
- A variety of handles in different styles are available as extras
- Made of bathroom-class material for humid environments

Colour

ART No. Price EUR
VAT 0%

EAN

Width 400 mm, depth 390 mm

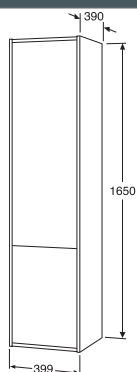

White	GB71ACTC40TM	1005	4065467171928
Black ash wood	GB71ACTC40TK	1226	4065467171942
Ash grey	GB71ACTC40TL	1005	4065467171935
Peach	GB71ACTC40TO	1005	4065467171959



Laundry basket
Pull-out laundry basket
for the lower section of
the high cabinet

GB71IGLB30

205

7391530074801

Colour

ART No. Price EUR
VAT 0%

EAN

Width 300 mm, depth 320 mm

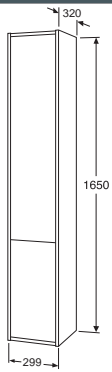

White	GB71ACTC30TM	953	4065467171881
Black ash wood	GB71ACTC30TK	1163	4065467171904
Ash grey	GB71ACTC30TL	953	4065467171898
Peach	GB71ACTC30TO	953	4065467171911



Leg frame with adjustable feet, 390 mm deep for wall cabinet or high cabinet (the cabinet must always be fixed to the wall)

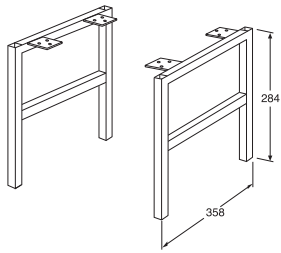

White	GB71ACLF39WM	269	4065467172086
-------	--------------	-----	---------------



Matt black	GB71ACLF39BL	253	4065467172093
------------	--------------	-----	---------------

Leg frame with adjustable feet, 320 mm deep for wall cabinet or high cabinet (the cabinet must always be fixed to the wall)

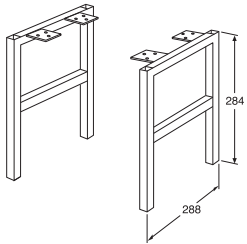

White	GB71ACLF32WM	264	4065467172109
-------	--------------	-----	---------------



Matt black	GB71ACLF32BL	249	4065467172116
------------	--------------	-----	---------------

Artic Small bathroom cabinets

Artic Small is a furniture series in a slim design for the small, cramped or asymmetrical toilet space. The concept is "mini" - but with the same high level of quality, design and ambition as products in our regular Artic serie.
Artic Small makes the small bathroom more beautiful and comfortable.

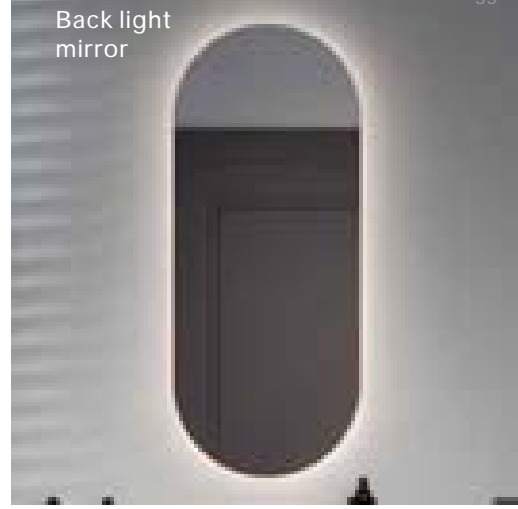

Bathroom cabinet with sink

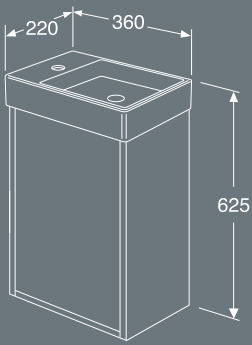

Wahsbasin colours



Soap dispenser holder



Furniture colours



High cabinet



HANDLES AND KNOBS

All handles and knobs fit all our bathroom furniture units. Several of the knobs can also be mounted on walls as towel hooks.



Artic Small bathroom cabinet with sink

- Furniture package with cabinet and washbasin
- The cabinet is delivered assembled
- Door with Soft Close for soft closing
- Reversible door for right- or left-hand installation
- One fixed shelf
- Opening in the cupboard for drainage towards the floor
- Available in several different colors with wash basins in glossy white, matt white or matt black
- Made in bathroom class material for humid environments
- Washbasin in hygienic, durable and tightly vitrified sanitary porcelain
- A variety of handles in different styles as extras
- Also available with handleless opening, push-open
- Water trap and bottom valve not included

Colour

ART No. Price EUR
VAT 0%

EAN

Bathroom cabinet with glossy white or matt white sink, basin on the right

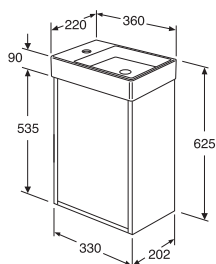

White – glossy white sink	GB71ACVC34TM01R	584	7391530084077
White – matt white sink	GB71ACVC34TMSWR	627	4065467459392
Black ash wood – glossy white sink	GB71ACVC34TK01R	637	7391530084107
Black ash wood – matt white sink	GB71ACVC34TKSWR	690	4065467459316
Ash grey – glossy white sink	GB71ACVC34TL01R	584	7391530084084
Ash grey – matt white sink	GB71ACVC34TLSWR	627	4065467459354
Peach – glossy white sink	GB71ACVC34T001R	584	7391530084091
Peach – matt white sink	GB71ACVC34TOSWR	627	4065467459279



Bathroom cabinet with matt black sink, basin on the right

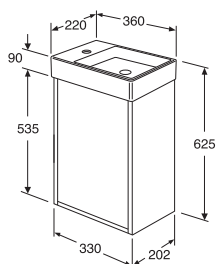

White	GB71ACVC34TM38R	627	4065467459415
Black ash wood	GB71ACVC34TK38R	690	4065467459330
Ash grey	GB71ACVC34TL38R	627	4065467459378
Peach	GB71ACVC34T038R	627	4065467459293



Bathroom cabinet with glossy white or matt white sink, basin on the left

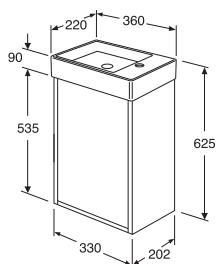

White – glossy white sink	GB71ACVC34TM01L	584	7391530084039
White – matt white sink	GB71ACVC34TMSWL	627	4065467459385
Black ash wood – glossy white sink	GB71ACVC34TK01L	637	7391530084060
Black ash wood – matt white sink	GB71ACVC34TKSWL	690	4065467459309
Ash grey – glossy white sink	GB71ACVC34TL01L	584	7391530084046
Ash grey – matt white sink	GB71ACVC34TLSWL	627	4065467459347
Peach – glossy white sink	GB71ACVC34T001L	584	7391530084053
Peach – matt white sink	GB71ACVC34TOSWL	627	4065467459262



Bathroom cabinet with matt black sink, basin on the left

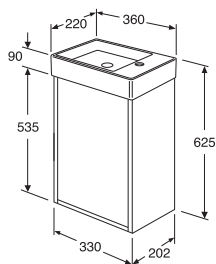

White	GB71ACVC34TM38L	627	4065467459408
Black ash wood	GB71ACVC34TK38L	690	4065467459323
Ash grey	GB71ACVC34TL38L	627	4065467459361
Peach	GB71ACVC34T038L	627	4065467459286



Artic Small high cabinet with mirror door

- Space-saving design and functional storage solutions for the small guest bathroom
- The cabinet is delivered assembled
- Door with Soft Close for soft closing
- Reversible door for right- or left-hand installation
- One fixed and two movable shelves
- Mirror on the door provides extra functionality without taking up more space
- Made in bathroom class material for humid environments
- Washbasin in hygienic, durable, and tightly vitrified sanitary porcelain
- A variety of handles in different styles as extras. Choose one to be mounted on the back of the door as drilling in the mirror is not an option
- Also available with handle less opening, push-open

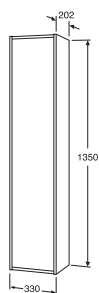

Colour

Colour	ART No.	Price EUR VAT 0%	EAN
White	GB71ACTC34TM	594	7391530083995
Black ash wood	GB71ACTC34TK	654	7391530084022
Ash grey	GB71ACTC34TL	594	7391530084008
Peach	GB71ACTC34TO	594	7391530084015



Water trap with bottom valve

- Pop up valve in chrome
- Fits drain connection to wall or floor



Colour

Water trap kit for Artic Small including pop-up valve in chrome

ART No.	Price EUR VAT 0%	EAN
GB7199WTACS	46	7391530084237
GB41636575 53	57	7393792234214



Matt black plug for bottom valve (for replacing the chromed version supplied)

Soap dispenser holder for mounting on wall

- Wall holder for soap pump in stripped-down design
- Fastens with strong double-sided tape

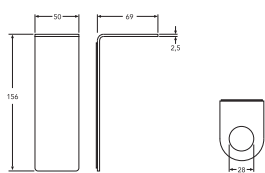

Colour

Colour	ART No.	Price EUR VAT 0%	EAN
Chrome	GB7199SDCR	33	7391530084206
Black	GB7199SDBL	33	7391530084213

Back light mirror

- Back lighted mirror for a pleasant mood light
- IP44-class
- Light source: LED
- Power: 14 W
- Colour temperature: 4000 K
- Lumen: 1392 lm
- Dimmable: No
- Lightsource included
- Voltage: 220-240 V
- Protection class: 2
- Converter included
- The electrical installation must be performed by an authorized electrician

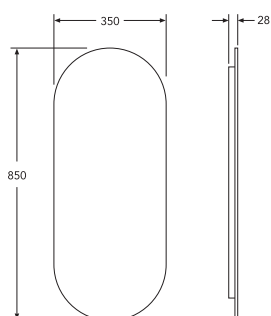

Colour

Mirror with lighting 35cm

ART No.	Price EUR VAT 0%	EAN
GB7199ML35	266	7391530084190

Graphic bathroom furniture

Graphic features slightly daintier dimensions than most other bathroom furniture units. The design is based on the repetition of graphic shapes and dimensions; for example, three wall cabinets on top of each other are exactly the same height as a high cabinet, making it easy to furnish with Graphic. Moreover, wall cabinets and high cabinets are available in two depths to suit both large and small bathrooms. Cabinet doors and frames of the same colour create a harmonious bathroom.

Mirror cabinet

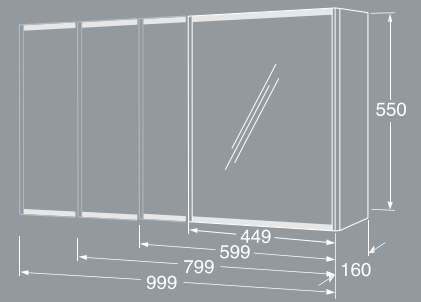

Mirrors and lighting for mirrors and mirror cabinets



Bathroom cabinet with sink



Wall cabinet

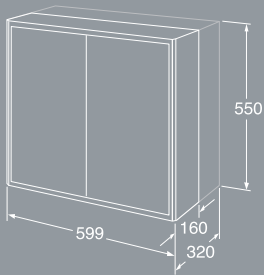

Colour



White



Green



Grey



Beige

High cabinet

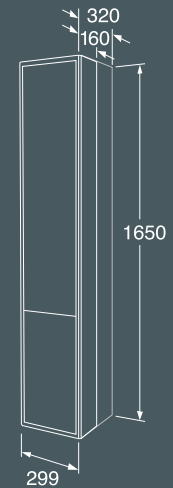

Storage cube

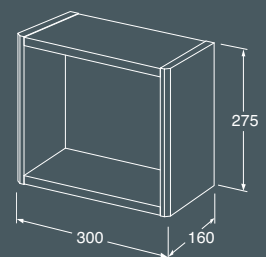

HANDLES AND KNOBS

All handles and knobs fit all our bathroom furniture units. Several of the knobs can also be mounted on walls as towel hooks.



Graphic bathroom cabinet with sink

- With a narrower depth to allow installation in even small bathrooms
- 'Secret compartment' for storing small items, and space for fitting an electrical socket
- The fold-out 'secret compartment' provides extra surface space when necessary and contains a knick-knack magnet
- Soft-close drawers for soft and silent closing
- Drawers with full-length pull-out for a complete overview of all your bits and bobs
- Space to run pipes behind the drawers
- Space-saving water trap with pop-up function included
- Available in four different colours
- Same material and colour on the cabinet frame, doors and drawers
- Material: Bathroom-class MDF adapted to humid environments
- Full-coverage porcelain washbasin
- Installation system that is quick and easy to fit on the wall and then adjust to the right position
- A variety of handles in different styles are available as extras
- Electrical socket and drawer insert available as extras

		Colour	ART No.	Price EUR VAT 0%	EAN
Width 450 mm					
		White	GB71GCVU45DHWB	1060	7391530068657
		Grey	GB71GCVU45GRWB	1196	7391530068695
		Green	GB71GCVU45GNWB	1252	7391530074832
		Beige	GB71GCVU45BBWB	1252	7391530084251
					
		Drawer insert, 450 mm. Fits the bottom drawer only	GB71GC DR45	114	
Width 600 mm					
		White	GB71GCVU60DHWB	1111	7391530068664
		Grey	GB71GCVU60GRWB	1255	7391530068701
		Green	GB71GCVU60GNWB	1315	7391530071169
		Beige	GB71GCVU60BBWB	1315	7391530084275
					
		Drawer insert, 600 mm. Fits the bottom drawer only	GB71GC DR60	114	7391530068381
Width 800 mm					
		White	GB71GCVU80DHWB	1222	7391530068671
		Grey	GB71GCVU80GRWB	1381	7391530068718
		Green	GB71GCVU80GNWB	1445	7391530071183
		Beige	GB71GCVU80BBWB	1445	7391530084299
					
		Drawer insert, 800 mm. Fits the bottom drawer only	GB71GC DR80	175	7391530068398

Colour

ART No. Price EUR
VAT 0%

EAN

Width 1000 mm

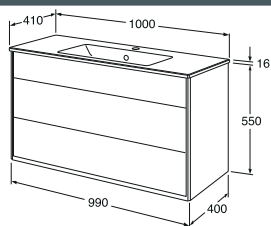

White	GB71GCVU10DHWB	1345	7391530068688
Grey	GB71GCVU10GRWB	1517	7391530068725
Green	GB71GCVU10GNWB	1588	7391530071206
Beige	GB71GCVU10BBWB	1588	7391530084312



Drawer insert, 1000 mm.
Fits the bottom drawer
only

GB71GCDR10

175

7391530068404

Graphic mirror cabinet

- Double-sided, soft-close mirror doors
- Two movable glass shelves
- Space to install an electrical socket
- Frosted bottom edge to prevent fingerprints on the mirror
- Material: Bathroom-class MDF adapted to humid environments
- Installation system that is quick and easy to fit on the wall and then adjust to the right position
- Bathroom light and electrical socket as extras
- Magnifying mirror included, for positioning as required
- Knick-knack magnet included, for positioning as required

Colour

ART No. Price EUR
VAT 0%

EAN

Width 450 mm

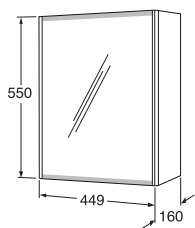

White	GB71GCMC45DH	472	7391530068121
Grey	GB71GCMC45GR	533	7391530068084
Green	GB71GCMC45GN	558	7391530071220
Beige	GB71GCMC45BB	558	7391530084336



Width 600 mm

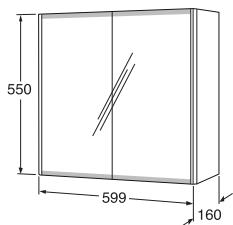

White	GB71GCMC60DH	575	7391530068091
Grey	GB71GCMC60GR	649	7391530068138
Green	GB71GCMC60GN	681	7391530071237
Beige	GB71GCMC60BB	681	7391530084343



Width 800 mm

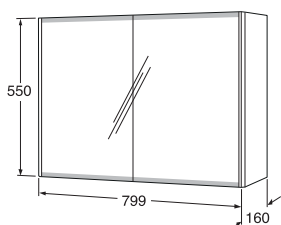

White	GB71GCMC80DH	645	7391530068107
Grey	GB71GCMC80GR	727	7391530068145
Green	GB71GCMC80GN	762	7391530071244
Beige	GB71GCMC80BB	762	7391530084350



Width 1000 mm

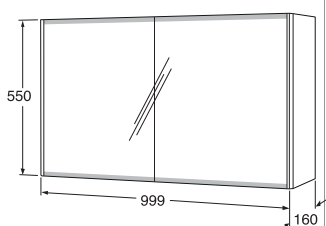

White	GB71GCMC10DH	690	7391530068114
Grey	GB71GCMC10GR	780	7391530068152
Green	GB71GCMC10GN	816	7391530071251
Beige	GB71GCMC10BB	816	7391530084367



Graphic wall cabinet

- Available in two depths for flexible storage, even in limited space
- Soft-close doors
- Two movable glass shelves
- Can be combined with multiple Graphic wall and high cabinets to create different storage modules
- Same material and colour on the cabinet frame and doors
- Material: Bathroom-class MDF adapted to humid environments
- Installation system that is quick and easy to fit on the wall and then adjust to the appropriate position
- Finish off with a top panel with integrated lighting
- A variety of handles in different styles are available as extras

Colour

ART No. Price EUR
VAT 0%

EAN

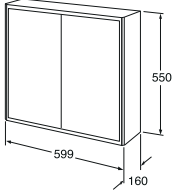

Depth 160 mm

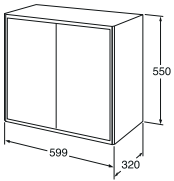

White	GB71GCSC6016DH	476	7391530068244
Grey	GB71GCSC6016GR	538	7391530068251
Green	GB71GCSC6016GN	564	7391530071282
Beige	GB71GCSC6016BB	564	7391530084398
 			

Depth 320 mm



White	GB71GCSC6032DH	562	7391530068275
Grey	GB71GCSC6032GR	634	7391530068282
Green	GB71GCSC6032GN	664	7391530071299
Beige	GB71GCSC6032BB	664	7391530084404
 			

Graphic storage cube

- Can be combined with Graphic wall cabinets to create storage modules
- Material: Bathroom-class MDF adapted to humid environments
- Installation system that is quick and easy to fit on the wall and then adjust to the appropriate position

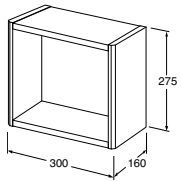

Colour

ART No. Price EUR
VAT 0%

EAN

White	GB71GCOS30DH	352	7391530071022
Grey	GB71GCOS30GR	397	7391530071039
Green	GB71GCOS30GN	438	7391530071053
Beige	GB71GCOS30BB	438	7391530084244
			

Graphic top panel for wall cabinet

- Expands surface space and elevates the appearance of your Graphic wall cabinet
- Two different lengths for fitting on one or two adjacent wall cabinets
- Converter included
- Not dimable
- Integrated LED-lighting illuminates the interior of the cabinet when the doors are open and adds decorative lighting when they are closed
- Material: Bathroom-class MDF and particle board adapted to humid environments

Colour

ART No. Price EUR
VAT 0%

EAN

For wall cabinet, depth 160 mm

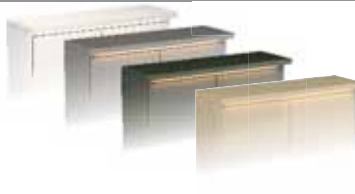
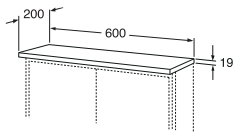

White, 3000 K, 120lm	GB71GCTP6016DH	450	7391530068305
Grey, 3000 K, 120lm	GB71GCTP6016GR	509	7391530068770
Green, 3000 K, 120lm	GB71GCTP6016GN	533	7391530071305
Beige, 3000 K, 120lm	GB71GCTP6016BB	533	7391530084411
			

Intended for two 600 mm cabinets fitted next to each other.

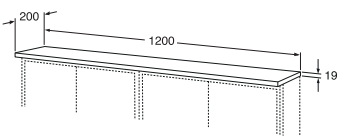

White, 3000 K, 260lm	GB71GCTP1216DH	493	7391530068312
Grey, 3000 K, 260lm	GB71GCTP1216GR	557	7391530068787
Green, 3000 K, 260lm	GB71GCTP1216GN	584	7391530071312
Beige, 3000 K, 260lm	GB71GCTP1216BB	584	7391530084428
			

Colour

ART No. Price EUR
VAT 0%

EAN

For wall cabinet, depth 320 mm

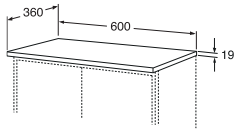

White, 3000 K, 120lm	GB71GCTP6032DH	585	7391530068329
Grey, 3000 K, 120lm	GB71GCTP6032GR	655	7391530068794
Green, 3000 K, 120lm	GB71GCTP6032GN	686	7391530071329
Beige, 3000 K, 120lm	GB71GCTP6032BB	686	7391530084435



Intended for two 600 mm cabinets fitted next to each other.

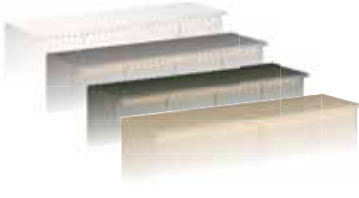
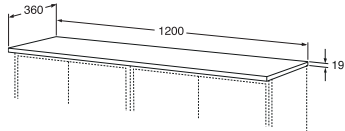

White, 3000 K, 260lm	GB71GCTPI232DH	644	7391530068336
Grey, 3000 K, 260lm	GB71GCTPI232GR	721	7391530068800
Green, 3000 K, 260lm	GB71GCTPI232GN	755	7391530071336
Beige, 3000 K, 260lm	GB71GCTPI232BB	755	7391530084442



Graphic high cabinet

- Available in two depths for flexible storage, even in limited space
- With a narrower depth (160 mm) to allow installation in even small bathrooms
- The deeper model (320 mm) features smart storage in the upper door
- Soft-close doors
- Reversible doors for right- or left-hand installation
- One fixed wooden shelf and four movable glass shelves
- Can be combined with other Graphic wall- and high cabinets to create storage modules
- One high cabinet is the same height as three Graphic wall cabinets
- Same material and colour on the cabinet frame and doors
- Material: Bathroom-class MDF adapted to humid environments
- Installation system that is quick and easy to fit on the wall and then adjust to the right position
- A variety of handles in different styles are available as extras

Colour

ART No. Price EUR
VAT 0%

EAN

Depth 160 mm

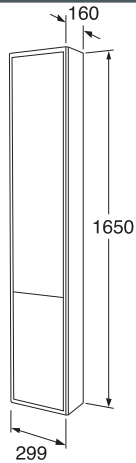

White	GB71GCTC16DH	727	7391530068183
Grey	GB71GCTC16GR	822	7391530068190
Green	GB71GCTC16GN	862	7391530071268
Beige	GB71GCTC16BB	862	7391530084374



Depth 320 mm

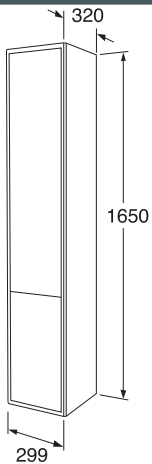

White	GB71GCTC32DH	856	7391530068213
Grey	GB71GCTC32GR	969	7391530068220
Green	GB71GCTC32GN	1014	7391530071275
Beige	GB71GCTC32BB	1014	7391530084381



Graphic Base bathroom furniture

Our popular Graphic range with Graphic Base: a simpler design and a lower price – so that even more people can enjoy the benefits a fully functional bathroom.

While there are still all kinds of smart Graphic solutions to choose from, Graphic Base is only available in white, and only with a smooth door finish. This, in turn, simplifies the choice of mixers and other accessories. We want it to be simple and straightforward for everyone to put together a neat and functional bathroom.

Mirror cabinet

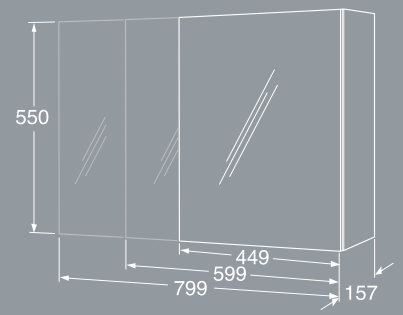

Bathroom cabinet with sink

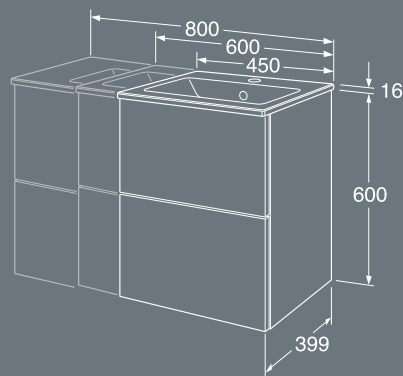

Colour



White

High cabinet

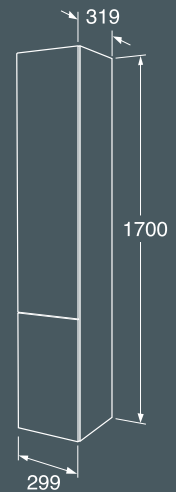

HANDLES AND KNOBS

All handles and knobs fit all our bathroom furniture units. Several of the knobs can also be mounted on walls as towel hooks.



Graphic Base bathroom cabinet with sink

- With a narrower depth to allow installation in even small bathrooms
- Space to fit an electrical socket in the drawer (optional extra)
- Soft-close draws for soft and silent closing
- Drawers with 3/4-length pull-out
- Space-saving water trap with pop-up function included
- Same material and colour on the cabinet frame, doors and drawers
- Material: moisture-resistant fibreboard rated for bathrooms
- Porcelain washbasin
- Installation system that is quick and easy to fit and adjust
- A variety of handles in different styles are available as extras

		Colour	ART No.	Price EUR VAT 0%	EAN
Width 450 mm					
		White	GB71GBVU45AGWB	694	7391530074818
Width 600 mm					
		White	GB71GBVU60AGWB	729	7391530074825
Width 800 mm					
		White	GB71GBVU80AGWB	802	7391530074832

Graphic Base mirror cabinet

- Double-sided, soft-close mirror doors
- Two movable glass shelves
- Space to install an electrical socket
- Material: moisture-resistant fibreboard rated for bathrooms
- Installation system that is quick and easy to fit on the wall
- Lighting and electrical socket as optional extras

		Colour	ART No.	Price EUR VAT 0%	EAN
Width 450 mm					
		White	GB71GBMC45AG00	415	7391530074764
Width 600 mm					
		White	GB71GBMC60AG00	508	7391530074771
Width 800 mm					
		White	GB71GBMC80AG00	568	7391530074788

Graptic Base high cabinet

- Soft-close doors
- Reversible doors for right- or left-hand installation
- Four movable glass shelves
- Material: moisture-resistant fibreboard rated for bathrooms
- Easy-to-fit installation system
- Pull-out laundry basket as an optional extra
- Same material and colour on the cabinet frame, doors and drawers
- A variety of handles in different styles are available as extras

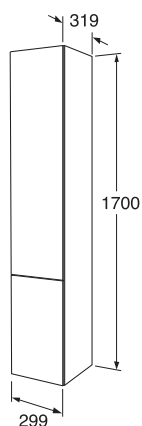

Colour

White



ART No. Price EUR
VAT 0%

EAN

GB71GBTC30AG 557 7391530074795

Pull-out laundry basket for high cabinet

- Pull-out laundry basket for the lower section of the high cabinet
- Removable metal wire basket for easy transport to the laundry room
- Supplied complete with installation fittings and pull-out rails
- Suitable for left- and right-hand installation



Colour

Grey

ART No. Price EUR
VAT 0%

EAN

GB71GBLB30 205 7391530074801

Mirrors and lighting

Don't forget about the lighting when planning your bathroom. Weak light – or excessively bright light – will make the bathroom environment dull and sad. A good rule of thumb is to have at least one light for 'general lighting' and one directed light for 'face work'.

Make sure to include mirrors in your calculations as well. It is quite usual to install a mirror above the washbasin, but if you have room, use mirrors as furnishing details – above a wall cabinet, for instance. Mirrors reflect light and increase the feeling of space in the room.

Lighting

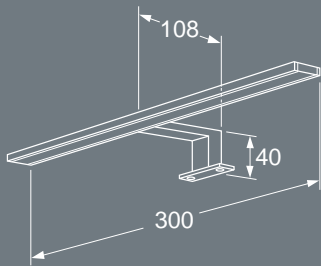

Colours

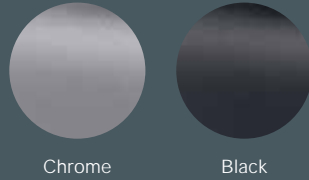

Mirrors

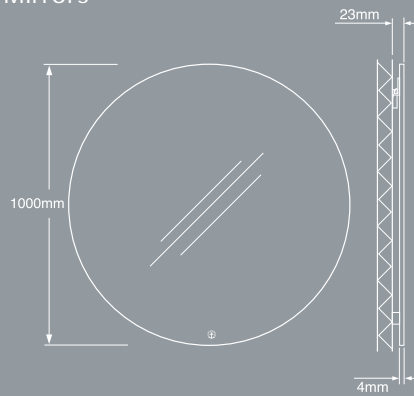

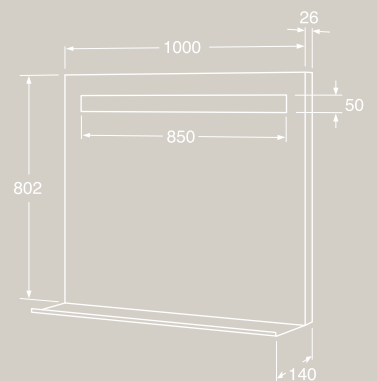

Mirror with lighting



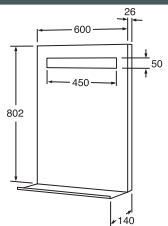

Mirror with lighting and black shelf

- All installation components supplied
- Light temperature 4000K
- IP44 classified
- Converter included
- Not dimmable
- Voltage: 220-240V
- The electrical installation must be performed by an authorised electrician
- The bottom shelf can be removed

	Colour	ART No.	Price EUR VAT 0%	EAN	
Width 600 mm					
		10W, 640lm	GB7199ML60BL	345	8435324905793
Width 800 mm					
		11W, 850lm	GB7199ML80BL	396	8435324905809
Width 1000 mm					
		13W, 1140lm	GB7199ML10BL	456	8435324905816
Width 1200 mm					
		15W, 1470lm	GB7199ML12BL	525	8435324905823

Mirrors

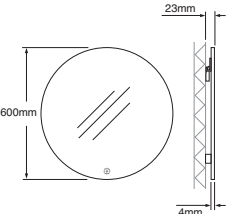
- All installation components supplied
- Simple installation with adjustable fitting
- Can be supplemented with lighting

	Colour	ART No.	Price EUR VAT 0%	EAN	
Ø 600 mm					
		Round	GB71GCMR60	166	7391530070995
Ø 800 mm					
		Round	GB71GCMR80	185	7391530071008

Colour

ART No. Price EUR
VAT 0%

EAN

Ø 1000 mm

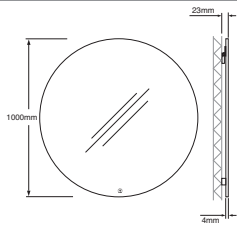

Round

GB71GCMR10

203

7391530071015

Width 450 mm



Rectangular

GB7148804500U

138

7391530070278

Width 600 mm



Rectangular

GB7148806000U

162

7391530066882

Width 800 mm

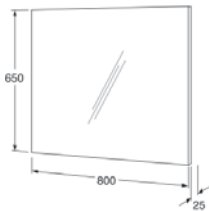

Rectangular

GB7148808000U

189

5705387002177

Width 1000 mm

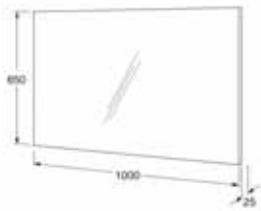

Rectangular

GB7148801000U

195

7391530066905

Width 1200 mm

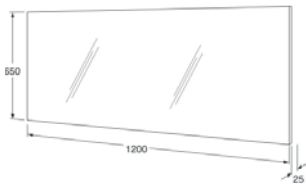

Rectangular

GB7148801200U

251

5705387002184

Lighting for mirror cabinets and mirrors

- All installation components supplied
- LED lighting
- Encapsulation class IP44
- Converter included
- Voltage: 220-240V



- Not dimmable
- The electrical installation must be performed by an authorised electrician

	Colour	ART No.	Price EUR VAT 0%	EAN	
Length 300 mm					
		Chrome, 3000 K, 400lm	GB71GCCL30	191	7391530068343
		Chrome, 4000 K, 400lm	GB71GCCL30CR4	203	7391530081380
		Black, 3000 K, 400lm	GB71GCCL30BL	191	4065467172284
Length 500 mm					
		Chrome, 3000 K, 640lm	GB71GCCL50	248	7391530068350
		Chrome, 4000 K, 640lm	GB71GCCL50CR4	255	7391530081397
		Black, 3000 K, 640lm	GB71GCCL50BL	248	4065467172291
Width 45 mm					
		Chrome/frosted glass, 3000 K, 260lm (1 pcs)	GB7148804601	126	7391530066226

Lighting for bathroom cabinet drawer or for effect lighting below bathroom cabinets

- Fits drawers in Graphic and Artic cabinets
- A sensor activates the lighting when the drawer is opened
- When fitted as effect lighting below bathroom cabinets, the lighting is connected to a wall switch
- 2.0 metre cable with cable duct for neat installation
- Power supply, 12V DC
- Light source LED



- Output 2.0 W
- Light temperature 3000K
- IP20 classified, for mounting outside of area 2 in the bathroom
- Converter included
- Not dimmable
- The electrical installation must be performed by an authorised electrician

	Colour	ART No.	Price EUR VAT 0%	EAN
	Drawer lighting set with converter	GB7199DLLRD	108	5705387009022
	Drawer lighting set without converter	GB7199DLLR	70	5705387009039

Electrical socket

- A space-saving electrical socket for positioning in the cabinet of your choice. For charging electric toothbrushes, or for using a hair dryer or electric razor
- All installation components supplied

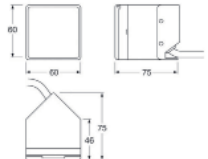
- Encapsulation class IP44
- The electrical installation must be performed by an authorised electrician

	Colour	ART No.	Price EUR VAT 0%	EAN	
		White	GB711800220	67	7391530066103

Handles and knobs

The cherry on top: the handles. The perfect way to change the expression of your bathroom, from trendy modern to traditional rural.

All handles and knobs fit all our bathroom furniture units.

Several of the knobs can also be mounted on walls as towel hooks.



Knobs

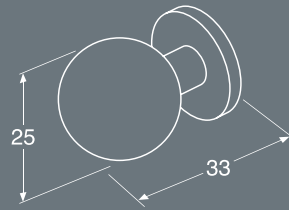



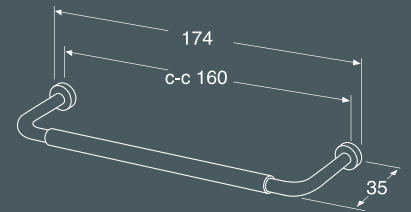





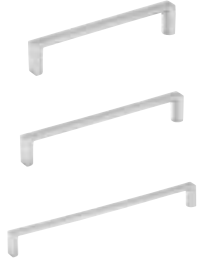









Handles



Handles and knobs

• Several of the knobs can also be mounted on walls as towel hooks

		Colour	Dimensions	ART No.	Price EUR VAT 0%	EAN
	Handles H2	Black/chrome	C-C between screws 96 mm	GB7199H2CW096	25	4120724077251
			C-C between screws 128 mm	GB7199H2CW128	25	7316181000405
	Handles H4	Chrome	C-C between screws 128 mm	GB7199H4CR128	15	7316181000443
			C-C between screws 160 mm	GB7199H4CR160	15	7316181000450
			C-C between screws 224 mm	GB7199H4CR224	22	7316181000467
	Handles H4	Black	C-C between screws 128 mm	GB7199H4BL128	15	7316183454329
			C-C between screws 160 mm	GB7199H4BL160	15	7316181000481
			C-C between screws 224 mm	GB7199H4BL224	22	7316181000498
	Handles H5	White	C-C between screws 32 mm	GB7199H5WH032	15	7316181000511
			C-C between screws 128 mm	GB7199H5WH128	15	7316181000528
	Handles H8	Chrome/ black leather	C-C between screws 160 mm	GB7199H8CB160	70	7391530071428
		Black/ black leather	C-C between screws 160 mm	GB7199H8BB160	70	7391530071442
	Handles H9	Black ash wood	C-C between screws 128 mm	GB7199H9BL128	22	4065467172215
		Black ash wood	C-C between screws 256 mm	GB7199H9BL256	27	4065467172239
		Natural oak	C-C between screws 128 mm	GB7199H9OK128	22	4065467172222
		Natural oak	C-C between screws 256 mm	GB7199H9OK256	27	4065467172246
	Handles H10	Black	C-C between screws 160 mm	GB7199H10BL160	22	4065467172161
		Black	C-C between screws 256 mm	GB7199H10BL256	27	4065467172185
		Brass	C-C between screws 160 mm	GB7199H10BR160	22	4065467172154
		Brass	C-C between screws 256 mm	GB7199H10BR256	27	4065467172178

		Colour	Dimensions	ART No.	Price EUR VAT 0%	EAN
	Knob K3 for furniture units	Black leather/ chrome	Length 65 mm	GB7199K3BCR00	24	7391530071473
		Brown leather/brass	Length 65 mm	GB7199K3BBR00	24	7391530071480
	Knob K1 for furniture units or walls	Porcelain/ brass	ø 30 mm	GB7199K1PB000	16	7316181000412
	Knob K2 for furniture units or walls	Chrome	ø 25 mm	GB7199K2CR000	13	7316181000504
	Knob K5 for furniture units or walls	Brass	ø 24 mm	GB7199K5BR000	17	7316181000580
	Knob K6 for furniture units or walls	Black	ø 27 mm	GB7199K6BL000	13	7316181000603
		White	ø 27 mm	GB7199K6WH000	13	7316181000610
	Knob K7 for furniture units or walls	Chrome	ø 25 mm	GB7199K7CR000	24	7391530071343
	Knob K8 for furniture units or walls	White marble/ brushed chrome	ø 28 mm	GB7199K8WM000	52	7391530071374
		Green marble/ brushed chrome	ø 28 mm	GB7199K8GM000	52	7391530071381
	Knob K9 for furniture units or walls	Brass	ø 16 mm	GB7199K9BR000	22	7391530071459
		Black	ø 16 mm	GB7199K9BL000	17	7391530071466
	Knob K10 for furniture units or walls	Black	Width 60 mm	GB7199K10BL00	17	4065467172208
		Brushed brass	Width 60 mm	GB7199K10BR00	17	4065467172208
	Knob K11 for furniture units or walls	Black	ø 28 mm	GB7199K11BL00	13	4065467172260
		Chrome	ø 28 mm	GB7199K11CR00	13	4065467172277
		Brushed brass	ø 28 mm	GB7199K11BR00	13	4065467172253
Push open function for bathroom cabinet drawers Artic An option if you prefer not to fit handles to the bathroom cabinet drawers						
	Push open set for 60 cm washstand			GB7199PU60	166	7391530079042
	Push open set for 80 cm washstand			GB7199PU80	186	7391530079059
	Push open set for 100 cm washstand			GB7199PU10	186	7391530079066
	Push open set for 120 cm washstand			GB7199PU12	186	7391530079073
Push open for doors in Artic, Artic Small or Graphic series						
	Push open set for door			GB7199PUDOOR	15	7391530084220

Artic Pro furniture for laundry areas

With Artic Pro – Gustavsberg's new range of products intended for the laundry area – you can make your laundry room or the laundry section of your bathroom as stylish as the rest of the bathroom.



HANDLES AND KNOBS

All handles and knobs fit all our bathroom furniture units. Several of the knobs can also be mounted on walls as towel hooks.

The wall cabinet – in white – is slightly taller than most other similar cabinets in order to facilitate storage.

Worktop sections in white or matte black are available to order in bespoke sizes to fit your laundry room precisely.



A white side section with adjustable feet effectively conceals the washing machine or laundry basket from the side.

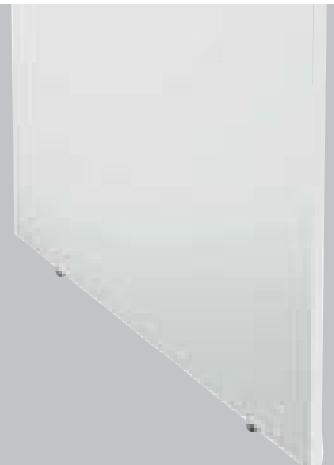





Artic Pro wall cabinet

- Soft-close door
- Two movable wood shelves
- Ideal for use as a top cabinet in a laundry room
- Installation system for quick and easy fitting on the wall
- A variety of handles in different styles are available as extras
- Made of bathroom-class material for humid environments

		Colour	ART No.	Price EUR VAT 0%	EAN
Width 600 mm					
		White	GB71ACSC6070TM	587	4065467172048
					
Width 400 mm					
		White	GB71ACSC4070TM	526	4065467172055
					

Artic Pro worktop

- Available in bespoke lengths – see the range of lengths in the item description
- Anti-fingerprint surface
- Extra scratch-proof and durable surface that is easy to keep clean
- Resistant to chemicals
- Free from nano-particles

		Colour	ART No.	Price EUR VAT 0%	EAN	
White						
		NB! State the exact measurement in mm when ordering	Length 200–740 mm	GB71WT0200TQ	282	7391530079110
			Length 741–1400 mm	GB71WT0741TQ	495	7391530079127
			Length 1401–1980 mm	GB71WT1401TQ	678	7391530079134
			Length 1981–2500 mm	GB71WT1981TQ	834	7391530079141
Matt black						
		NB! State the exact measurement in mm when ordering	Length 200–740 mm	GB71WT0200TN	282	7391530079158
			Length 741–1400 mm	GB71WT0741TN	495	7391530079165
			Length 1401–1980 mm	GB71WT1401TN	678	7391530079172
			Length 1981–2500 mm	GB71WT1981TN	834	7391530079189

Artic pro angle fitting and bracket for installing the worktop					
		Angle fitting	GB71WTBRKT	169	7391530079080
		Bracket	GB71WTCONS	169	7391530079097

Artic Pro covering side

- Matches the depth of the worktop
- Conceals the washing machine or laundry basket
- The adjustable foot lifts the side section a little way off the floor to eliminate the risk of moisture damage

		Colour	ART No.	Price EUR VAT 0%	EAN
		White	GB71WTSPAG	169	7391530079103

Plan with the bathroom planner

With Gustavsberg's bathroom planner, you can draw up your bathroom and test which furniture and other products you want in your bathroom. You will find the bathroom planner, inspiration and information about our wide range for the entire bathroom on our website.

Welcome to [gustavsberg.com](https://www.gustavsberg.com)



Mixers

Gustavsberg has been a world leader in technology that saves water, energy and money since the 1970s. Today, we enjoy a deserved reputation for our environmentally certified and -declared products, and many of our mixers meet the requirements of various environmental assessment systems. Our plant in Vårgårda, Sweden, where we have been manufacturing mixers since 1920, is ISO certified in the fields of quality, the environment, energy and work environment.

Selecting a Gustavsberg mixer is a simple way to make a sustainable and confident choice. Not forgetting the fact that it will be an ornament to your bathroom.

THINGS TO THINK ABOUT

Spend a little time studying all the innovative functions of our mixers (see below). You are sure to pick up on some smart function or other that will facilitate or enrich your life in the bathroom. Do you have young children? Then choose a smart thermostatic mixer that regulates the water temperature and eliminates the risk of scalding.



COLD-START

Innovative technology ensures that the mixer supplies 100% cold water from its start position – facing forward – eliminating unnecessary use of hot water. Saves energy and money every time you use it.



EVEN TEMPERATURE

Thermostatic mixers feature built-in automatic scald protection and hot-water safety stop with type-approved non-return valves. This means that the mixers react quickly to the changes in temperature and pressure that can arise in the water flow, and even out the differences.



ELECTRONIC SHUT-OFF VALVE

The smart self-closing valve increases water safety in your kitchen. Choose between three timing settings when the valve is open. A discreet led lamp (green, blue, yellow) communicates your selected time setting and turns off when the valve is closed.



QUICK FIT

The mixer is installed using a quick fit nut that is simply pushed up to its stop position and then tightened. This smart solution simplifies installation and saves time, money and sore backs!



ADJUSTABLE FLOW

A smart eco-function that allows individual setting of the max flow of the mixer. This makes it simple for you to adjust the max flow, saving water and energy on your own terms. The function is fully adjustable for individual setting.



SAFE TOUCH

All thermostatic mixers from Gustavsberg are fitted with a safe touch function, which means they are designed to lead the hot water along the rear side of the mixer. This minimises the heat level on the front side of the thermostat, thus reducing the risk of burns.



LEAKAGE BREAKER

If water comes into contact with the detector, the valve closes immediately and the leakage breaker's red led lamp will flash. Even if the valve is closed, the led lamp flashes if there are leakages from other devices.



SMART INSIDE

Thanks to the smart, replaceable components, the mixer can be upgraded in the future to add new, even smarter functions. This extends the mixer's lifetime and makes it even more sustainable.



ECO-FLOW

The mixer features an effective, optimised flow of water. You therefore enjoy the same wonderful, functional experience as always, but using less water and energy. Kind on the environment – and on your wallet.



LEAD-FREE

The mixer is made of material whose total weight includes less than 0.1% Lead. As such, it is an eco-smart mixer that meets stringent requirements with reference to lead content. The mixer features a discreet laser marked symbol on its rear side to facilitate traceability.



DUAL FUNCTION

The mixer is operated as normal with a lever, but is also fully control-lable with the digital control. A led light communicates the selected temperature. For smarter use, flow and temperature can be program-med in three favourite settings that are activated via quick select.



Estetic shower mixer, rotatable spout with reverse function and with smart click-on shelf.

Estetic washbasin mixer

- Organic design idiom that matches bathrooms of all kinds
- The extra tall model suits both kitchen sinks and top-mounted bathroom sinks
- Adjustable flow - facilitates, adjustable maximum flow
- Adjustable max. temperature for improved scald protection
- Type approved flexible water connection for easier installation
- Available in several color options

			ART No.	Price EUR VAT 0%	EAN
		Estetic washbasin mixer Chrome Matt white Matt black	GB41218051 GB41218051 41 GB41218051 53	155 354 202	7393792230391 7393792230414 7393792230407
		Estetic washbasin mixer, tall model, functions as a kitchen faucet or with top-mounted bathroom sinks Chrome Matt white Matt black	GB41218251 GB41218251 41 GB41218251 53	271 486 352	7393792230421 7393792230445 7393792232197
		Estetic push-down valve with porcelain plug (chrome in metal) Chrome Standard white Matt white Black Matt black	GB41636575 01 GB41636575 25 GB41636575 41 GB41636575 23 GB41636575 53	38 78 94 94 57	7393792214308 7393792230797 7393792230803 7393792230810 7393792234214

Epic washbasin mixer

- Contemporary design
- Eco-flow for efficient water- and energy consumption
- Soft move ceramic inside ensures soft and precise manoeuvring
- Adjustable max. temperature for improved scald protection
- Approved flexible water connection for easier installation
- Washbasin mixer with side shower facilitates cleaning and intimate hygiene
- Available in several color options

			ART No.	Price EUR VAT 0%	EAN
		Epic washbasin mixer Chrome Matt black Brushed brass	GB41219951 GB41219951 53 GB41219951 24	152 198 224	7393792233736 7393792233750 7393792233743
		Epic washbasin mixer with self-closing hand spray and wall attachment, hose 1,75m Chrome Matt black Brushed brass	GB41219961 GB41219961 53 GB41219961 24	248 322 364	7393792233767 7393792233781 7393792233774
		Push-down valve Chrome Matt black Brushed brass	GB41636575 01 GB41636575 53 GB41636575 24	38 57 94	7393792214308 7393792234214 7393792234207











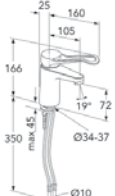

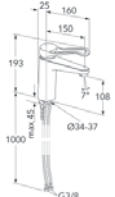
New Nautic washbasin mixer

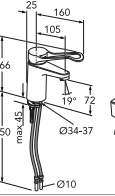
- Energy classification A saves water and energy
- Grip-friendly lever with clear color marking for hot and cold water
- Cold-start, supplies only cold water when the lever is in straight forward position (applies to energy class A)
- Eco-flow for efficient water- and energy consumption
- Adjustable flow - facilitates, adjustable maximum flow limitation
- Soft move, ceramic seal ensures soft and precise maneuvering
- Smart inside, sustainable construction for the requirements of the future
- Adjustable max. temperature for improved scald protection
- Directed water angle provides less splashing and plenty of room for hands
- Patented quick mounting nut for easy installation

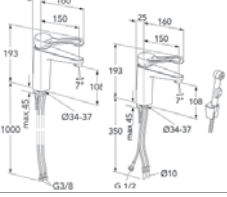
		ART No.	Price EUR VAT 0%	EAN
		New Nautic washbasin mixer, energy class A Lead-free Lead-free, Eco-Flow max 1,9 l/m Lead-free, Eco-Flow max 3 l/m Eco-Flow max 3 l/m With G3/8" connection		
		GB41216047	148	7393792234788
		GB412160470	170	7393792235013
		GB412160470LB	187	7391530081885
		GB412160470B	179	7391530081892
		GB41216047B	155	7391530081878
GB41216047R	163	7393792234856		
		New Nautic washbasin mixer with hand spray and wall bracket, energy class A Lead-free Lead-free, Eco-Flow max 3 l/m		
		GB41216147	192	7393792234993
		GB412161470	221	7393792234986
GB412161470B	232	7391530081854		
		New Nautic washbasin mixer with washing machine turn off, hand spray and wall bracket, energy class A		
		GB41216187	298	7393792234962
		New Nautic washbasin mixer, 150 mm spout, energy class A Lead-free Lead-free, Eco-Flow max 3 l/m With G3/8" connection		
		GB41216045	170	7393792235082
		GB412160450	196	7393792235129
		GB412160450B	206	7391530081915
GB41216045R	187	7393792235099		
		New Nautic washbasin mixer, 150 mm spout, with hand spray and wall bracket, energy class A Lead-free		
		GB41216145	221	7393792235068
GB412161450	254	7393792235051		
		New Nautic washbasin mixer, 150 mm spout, with washing machine turn off, hand spray and wall bracket, energy class A		
		GB41216185	343	7393792235075

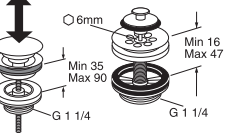
New Nautic Care washbasin mixer

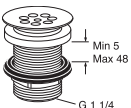
- Energy classification A saves water and energy
- Function adapted lever with clear color marking for hot and cold water
- Laminar aerator that counteracts aerosols
- Cold-start, supplies only cold water when the lever is in straight forward position (applies to energy class A)
- Eco-flow for efficient water- and energy consumption
- Adjustable flow - facilitates, adjustable maximum flow
- Soft move, ceramic seal ensures soft and precise manoeuvring
- Smart inside, sustainable construction for the requirements of the future
- Adjustable max. temperature for improved scald protection
- Directed water angle provides less splashing and plenty of room for hands
- Coated flexible water connection for improved hygiene
- Ceramic seal to prevent dripping and ensure a long service life
- Patented quick mounting nut for easy installation

		ART No.	Price EUR VAT 0%	EAN	
		New Nautic Care washbasin mixer, energy class A Lead-free	GB41216047064	196	7393792235006
		Lead-free, Eco-Flow max 1,9 l/m	GB41216047064LB	216	7391530081908
		New Nautic Care washbasin mixer, 150 mm spout, energy class A Lead-free	GB41216045064	225	7393792235112
		New Nautic Care washbasin mixer with hand spray and wall bracket Lead-free, Eco-Flow max 3 l/m	GB41216147064B	267	7391530081861
		New Nautic Care washbasin mixer, 150 mm spout, with hand spray and wall bracket, energy class A Lead-free	GB41216145064	292	7391530080444
		Bottom valves			
		Push-down valve	GB41636575 01	38	7393792214308
		Bottom plug for washbasins without overflow	GB41637445	26	7393792221719
		Bottom valve	GB41636574 01	41	7393792231596
		For washbasins without overflow			

Atlantic washbasin mixer

- Adjustable max. temperature for improved scald protection
- Eco-flow for efficient water- and energy consumption
- Adjustable flow - facilitates, adjustable maximum flow
- Cold-start, supplies only cold water when the lever is in straight forward position
- Ceramic seal to prevent dripping and ensure a long service life
- Type-approved, flexible water connection for simpler installation
- Atlantic is also available in models that contain less than 0.1% lead and energy class A

		ART No.	Price EUR VAT 0%	EAN	
		Atlantic washbasin mixer			
		Chrome	GB41215047	141	7393792232340
		Mat t black	GB4121504753	183	7391530084879
		Lead-free and energy classified A			
		Chrome	GB41215047 0	162	7393792232357
		Atlantic washbasin mixer with hand spray and wall bracket			
		Chrome	GB41215147	183	7393792232364

Nordic³ washbasin mixer

- Contemporary design by Propeller
- Soft move ceramic seal ensures soft and precise manoeuvring

- Adjustable max. temperature for improved scald protection
- Type approved flexible water connection for easier installation

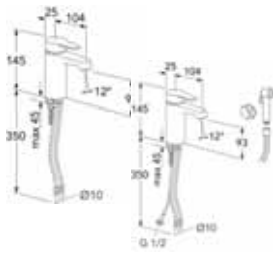

Nordic³ washbasin mixer

Chrome
Chrome with hand spray and wall bracket

ART No.

Price EUR
VAT 0%

EAN

GB41213451

138

7393792233132

GB41213461

179

7393792233149

Nordic Plus washbasin mixer

- Contemporary design by Propeller
- Soft move ceramic seal ensures soft and precise manoeuvring

- Adjustable max. temperature for improved scald protection
- Type approved flexible water connection for easier installation

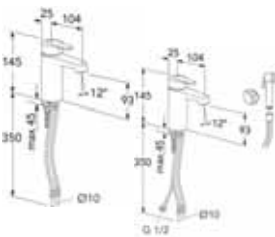

Nordic Plus washbasin mixer

Chrome
Chrome with hand spray and wall bracket

ART No.

Price EUR
VAT 0%

EAN

GB41213751

138

7393792233217

GB41213761

179

7393792233224

Dynamic washbasin mixer

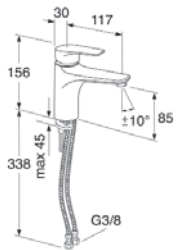

Dynamic washbasin mixer

Chrome
Supplement:
Chrome ring cover

GB41214352

120

7393792232890

GB4165025401

9

7391530081700

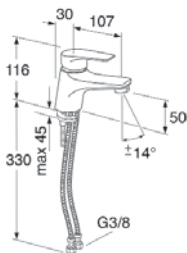

Dynamic washbasin mixer low

Chrome
Supplement:
Chrome ring cover

GB41214351

114

7393792232883

GB4165025401

9

7391530081700

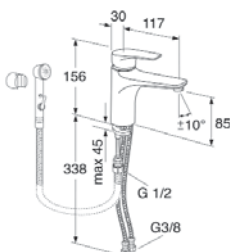

Dynamic washbasin mixer with self-closing hand spray and wall attachment, hose 1,75m

Chrome
Supplement:
Chrome ring cover

GB41214361

156

7393792232906

GB4165025401

9

7391530081700

Sensoric washbasin mixer

- Fits just as well at home as in a public environment
- Contains less than 0.1% lead
- Can be modified for pre-temperature or cold water only
- 9V system, batteries (AA standard) are included
- Possible to add a 240 V supply (3m cable)
- Leed & Breeam adapted flow, limited to 1,9 or 4,5 l/min (PCA aerators included in package)
- Backflow protection in accordance with SS-EN 1717 [AA]
- Max flow time 1 min

			ART No.	Price EUR VAT 0%	EAN
		Sensoric washbasin mixer 1.0			
		Chrome	GB41218881	280	7391530080826
		Matt black	GB4121888153	364	7391530082820
		Sensoric washbasin mixer 1.0 incl distance ring 160 mm			
		Chrome	GB41218281	296	7391530080925
		Matt black	GB4121828153	385	7391530083919
		Sensoric washbasin mixer 1.0 incl distance ring 240 mm			
		Chrome	GB41218481	320	7391530080932
		Matt black	GB4121848153	416	7391530083926
		Sensoric washbasin mixer 1.0 accessories			
		Distance ring Sensoric 1.0 160 mm			
		Chrome	GB4165034101	22	7391530080901
		Matt black	GB416503410153	34	7391530082837
		Distance ring Sensoric 1.0 240 mm			
		Chrome	GB4165034201	54	7391530080918
		Matt black	GB416503420153	70	7391530082844

New Nautic bidet mixer

- Grip-friendly lever with clear color marking for hot and cold water
- Adjustable flow - facilitates, adjustable maximum flow
- Soft move, ceramic seal ensures soft and precise maneuvering
- Smart inside, sustainable construction for the requirements of the future
- Directed spout angle gives less splash and more space for hands
- Adjustable max. temperature for improved scald protection
- Patented quick mounting nut for easy installation

			ART No.	Price EUR VAT 0%	EAN
		Nautic bidet mixer with ball-jointed aerator			
		With waste fitting with lifting shaft	GB41216071	191	7393792235563

Atlantic bidet mixer

- Adjustable max. temperature for improved scald protection
- Eco-flow for efficient water- and energy consumption
- Adjustable flow - facilitates adjustable maximum flow
- Ceramic seal to prevent dripping and ensure a long service life
- Type-approved, flexible water connection for simpler installation
- Backflow protection in accordance with SS-EN 1717 [AA]

			ART No.	Price EUR VAT 0%	EAN
		Atlantic bidet mixer with ball-jointed aerator			
		With waste fitting with lifting shaft	GB41215072	181	7391530084862

New Nautic thermostatic mixer

- Built-in automatic hot water block for scald protection
- Block button on the temperature side at comfort temperature 38°C
- Adjustable max temperature for increased scald protection
- Safe Touch reduces the heat on the front of the mixer
- Block button on flow side at comfort flow
- Responds quickly to changes in pressure and temperature, maintaining even water temperature
- Ceramic shut-off for drip protection and long life, also simplifies use for small and weak hands
- Type-approved check valve in the inlets
- Backflow protection in accordance with SS-EN 1717 [EB]
- Can be functionally adapted with grip-friendly knobs
- Can be complemented with a Gustavsberg bathtub spout
- Can be complemented with a smart click-on shelf

		ART No.	Price EUR VAT 0%	EAN	
		Lead free, with outlet up and down 	GB412123020	281	7391530076379
		With outlet down 	GB41212304	213	7391530076270
		Lead free, with outlet down 	GB412123040	245	7391530075860
		Lead free, with outlet down, with grip-friendly knobs 	GB41212304066	282	7391530075877
		With outlet down, with swiveling bathtub spout 	GB41212323	262	7391530081298
		With outlet down, with 85 mm fixed bathtub spout 	GB41212352	248	7391530081304
		Lead free, with outlet down, with 85 mm fixed bathtub spout 	GB412123520	285	7391530081311
		Lead free, with outlet up and down, with 350 mm swiveling spout 	GB412123610	285	7391530081335

			ART No.	Price EUR VAT 0%	EAN
		<p>Lead free, with outlet up and down, incl. energy class A rain shower</p>	GB412123300	654	7391530076386
		<p>With outlet down, incl. energy class A shower set</p>	GB41212387	305	7391530075891
		<p>With outlet down, with fixed bathtub spout</p>	GB41212333	276	7391530075938





New Nautic thermostatic mixer with shower set Round and Square

- Super slim shower head Ø250 mm / 250x250 mm
- Easy clean - designed with smart nozzles that make it simple to wipe off any limescale deposits
- The head shower and shower arm are turnable and can be adjusted completely individually
- 400 mm long shower arm provides a generous shower area
- Telescopically adjustable height 770-1165 mm
- Flexible wall bracket 50-130 mm for easy installation
- 3-functional hand shower with a button
- Hand shower on glider
- 1,75 m metal braided shower hose
- Knob with clear color marking for hot and cold
- Built-in automatic hot water shut-off for scalding protection
- Block button on the temperature side at a comfort temperature of 38°C
- Safe Touch, minimizes the heat on the front of the mixer
- Reacts quickly to pressure and temperature changes in the water flow, which provides an even water temperature
- Ceramic shut-off for drip protection and long life, also simplifies use for small and weak hands
- Type-approved non-return valves in the inlets
- Can be complemented with a smart click-on shelf
- Can be functionally adapted with grip-friendly knobs

			ART No.	Price EUR VAT 0%	EAN
		<p>With outlet up and down, with rain shower head Round</p>	GB41212330	569	7391530076287
		<p>With outlet up and down, with rain shower head Square</p>	GB41212335	569	7391530085302

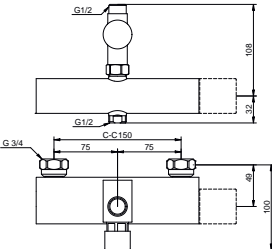
New Nautic thermostatic mixer with pressure valve and showerset Public

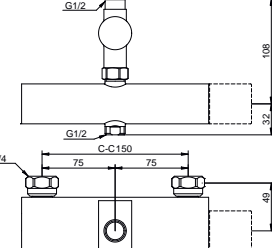
- Preset flushing time – 30 sek.
- Flow 9 l/min at 3 bar
- Built-in automatic hot water block for scald protection
- Adjustable max temperature for increased scald protection
- Block button on the temperature side at comfort temperature 38°C
- Safe Touch, minimizes the heat on the front side of the mixer
- Reacts quickly to changes in the flow pressure and temperature to maintain a constant water temperature
- Type-approved non-return valves in the inlets
- Backflow protection in accordance with SS-EN 1717 [EB]
- Can be functionally adapted with grip-friendly knobs

		ART No.	Price EUR VAT 0%	EAN
		GB41212355	476	7391530081328
		GB41212364	370	7391530075723



New Nautic pre-rinse set

- Functional, ergonomic design
- Hand-held rinsing nozzle that minimizes pressure surges when the water flow is opened and closed, can be locked for longer flushes
- The nozzle features two different spray patterns, both with optimized rinsing capacities
- Diverter function built into the thermostatic mixer
- Safe Touch reduces the heat on the front side of the mixer
- Reacts quickly to changes in pressure and temperature, maintaining even water temperature
- Built-in automatic hot water block for complete scald protection
- Easy to install
- Complete with 350 mm pivoting spout

		ART No.	Price EUR VAT 0%	EAN
		GB41212372	1040	7391530075914











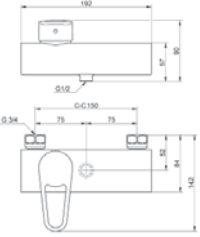



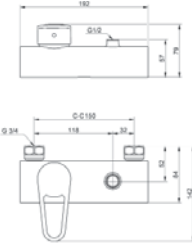



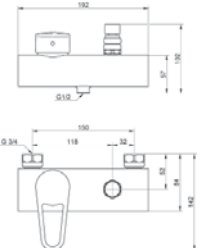



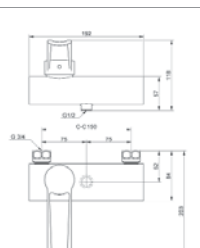

Accessories

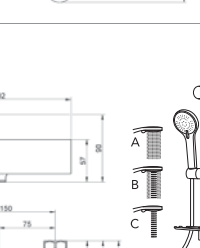
- Provides neater assembly and a flat surface on top of the mixer
- Fits all thermostatic mixers in the New Nautic, Atlantic and Nordic series (Included in delivery in Estetic series)

	Click-on shelf	GB41650052	8	7391530077086
	Click-on shelf, matt black	GB4165005253	10	7391530081991

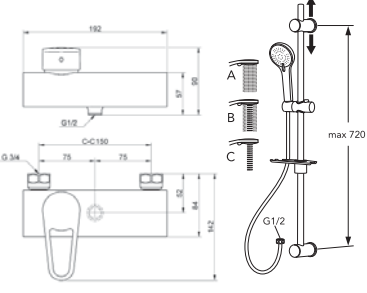
New Nautic shower mixer

- Grip-friendly lever with with clear color marking for hot and cold
- Soft move ceramic inside ensures soft and precise maneuvering
- Adjustable flow – facilitates adjustable maximum flow
- Adjustable max temperature for increased scald protection
- Ceramic seal to prevent dripping and ensure a long service life
- Backflow protection in accordance with SS-EN 1717 [AA]
- Type approved backflow valve in the shower connection
- Can be supplemented with elongated lever for functionality adaptation

		ART No.	Price EUR VAT 0%	EAN	
		With outlet down  	GB41212014	209	7391530081762
		With outlet up  	GB41212024	223	7391530081748
		With vacuum valve and with inlet backflow protection  	GB41212274	250	7391530081724
		Lead free, with vacuum valve and with inlet backflow protection   	GB412122740	288	7391530081717
		Lead free, with outlet down   	GB41212014064	276	7391530081755
		Shower mixer including energy class A shower set  	GB41212087	284	7391530081731

Atlantic thermostatic mixer

- Knob with clear color marking for hot and cold
- Built-in automatic hot water shut-off for scalding protection
- Adjustable max temperature for increased scald protection
- Block button on the temperature side at a comfort temperature of 38°C
- Safe Touch reduces the heat on the front of the mixer
- Reacts quickly to pressure and temperature changes in the water flow, which provides an even water temperature
- Ceramic shut-off for drip protection and long life, also simplifies use for small and weak hands
- Type-approved non-return valves in the inlets
- Backflow protection in accordance with SS-EN 1717 [AA]
- Can be completed with a Gustavsberg bathtub spout
- Can be complemented with a smart click-on shelf

			ART No.	Price EUR VAT 0%	EAN
		With outlet up and down 	GB41211302	232	7391530076393
		With outlet down 	GB41211304	202	7391530076430
		Lead free, with outlet down 	GB412113040	212	7391530076447
		Lead free, outlet down, incl. energy class A rain shower 	GB412113870	344	7391530076461







Atlantic thermostatic mixer with shower set Round and Square

- Super slim shower head Ø250 mm / 250x250 mm
- Easy clean - designed with smart nozzles that make it simple to wipe off any limescale deposits
- The head shower and shower arm are turnable and can be adjusted completely individually
- 400 mm long shower arm provides a generous shower area
- Telescopically adjustable height 770-1165 mm
- Flexible wall bracket 50-130 mm for easy installation
- 3-functional hand shower with a button
- Hand shower on glider
- 1,75 m metal braided shower hose
- Knob with clear color marking for hot and cold
- Built-in automatic hot water shut-off for scalding protection
- Block button on the temperature side at a comfort temperature of 38°C
- Safe Touch, minimizes the heat on the front of the mixer
- Reacts quickly to pressure and temperature changes in the water flow, which provides an even water temperature
- Ceramic shut-off for drip protection and long life, also simplifies use for small and weak hands
- Type-approved non-return valves in the inlets
- Can be functionally adapted with grip-friendly knobs
- Can be complemented with a smart click-on shelf

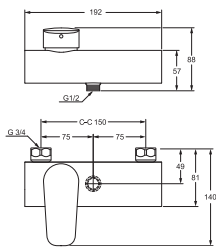
			ART No.	Price EUR VAT 0%	EAN
		With outlet up and down, with rain shower head Round 	GB41211330	541	7391530076454
		With outlet up and down, with rain shower head Square 	GB41211335	541	7391530082813

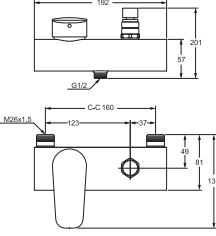

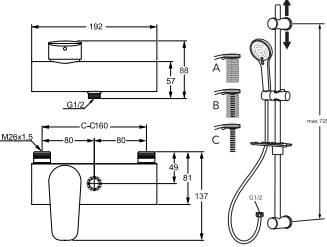

Atlantic shower mixer

- Grip-friendly lever with with clear color marking for hot and cold
- Soft move ceramic inside ensures soft and precise manoeuvring
- Adjustable flow – facilitates adjustable maximum flow
- Adjustable max temperature for increased scald protection
- Ceramic seal to prevent dripping and ensure a long service life
- Type approved backflow valve in the shower connection
- Backflow protection in accordance with SS-EN 1717 [EB]
- Can be supplemented with elongated lever for functionality adaptation

			ART No.	Price EUR VAT 0%	EAN
		With outlet down 	GB41211314	199	7391530084817
		With vacuum valve and with inlet backflow protection 	GB41211374	238	7391530085074
		Shower mixer including energy class A shower set 	GB41211387	275	7391530085050

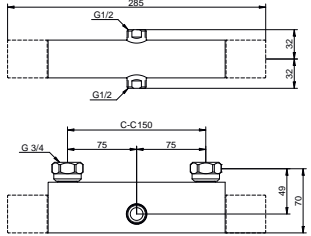
Nordic thermostatic mixer

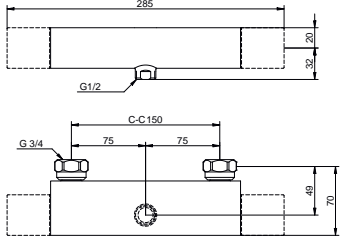
- Built-in automatic hot water shut-off for scalding protection
- Block button on the temperature side at a comfort temperature of 38°C
- Adjustable max temperature for increased scald protection
- Safe Touch reduces the heat on the front of the mixer
- Reacts quickly to pressure and temperature changes in the water flow, which provides an even water temperature
- Ceramic shut-off for drip protection and long life, also simplifies use for small and weak hands
- Type-approved non-return valves in the inlets
- Backflow protection in accordance with SS-EN 1717 [AA]
- Can be completed with a Gustavsberg bathtub spout
- Can be complemented with a smart click-on shelf

			ART No.	Price EUR VAT 0%	EAN
		With outlet up and down 	GB41211702	227	7391530077024
		With outlet down 	GB41211704	197	7391530077031

Nordic thermostatic mixer with shower set Round and Square

- Super slim shower head Ø250 mm / 250x250 mm
- Easy clean - designed with smart nozzles that make it simple to wipe off any limescale deposits
- The head shower and shower arm are turnable and can be adjusted completely individually
- 400 mm long shower arm provides a generous shower area
- Telescopically adjustable height 770-1165 mm
- Flexible wall bracket 50-130 mm for easy installation
- 3-functional hand shower with a button
- Hand shower on glider
- 1,75 m metal braided shower hose
- Knob with clear color marking for hot and cold
- Built-in automatic hot water shut-off for scalding protection
- Block button on the temperature side at a comfort temperature of 38°C
- Safe Touch, minimizes the heat on the front of the mixer
- Reacts quickly to pressure and temperature changes in the water flow, which provides an even water temperature
- Ceramic shut-off for drip protection and long life, also simplifies use for small and weak hands
- Type-approved non-return valves in the inlets
- Can be functionally adapted with grip-friendly knobs
- Can be complemented with a smart click-on shelf

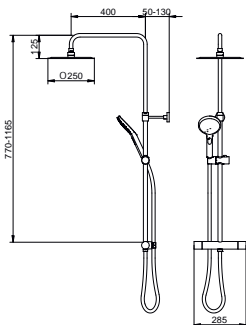

With outlet up and down,
with rain shower head Round



ART No. Price EUR
VAT 0% EAN

GB41211730 527 7391530077048

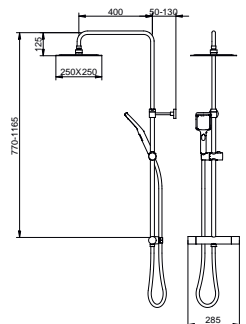

With outlet up and down,
with rain shower head Square



GB41211735 527 7391530077055

Estetic thermostatic mixer

- Organic design that suits all types of bathrooms
- Built-in automatic hot water shut-off for scalding protection
- Block button on the temperature side at a comfort temperature of 38°C
- Adjustable max temperature for increased scald protection
- Safe Touch reduces the heat on the front of the mixer
- Reacts quickly to pressure and temperature changes in the water flow, which provides an even water temperature
- Ceramic shut-off for drip protection and long life, also simplifies use for small and weak hands
- Type-approved non-return valves in the inlets
- Backflow protection in accordance with SS-EN 1717 [AA]
- Available in chrome and matt black
- Can be combined with all outlet pipes
- A smart click-on shelf is included

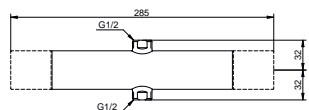

With outlet up and down
Chrome



ART No. Price EUR
VAT 0% EAN

GB41218402 257 7391530076164

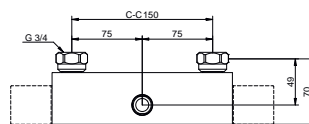

With outlet up and down
Matt black



GB4121840253 334 7391530076171

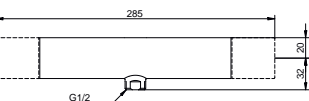

With outlet down
Chrome



GB41218404 224 7391530076188

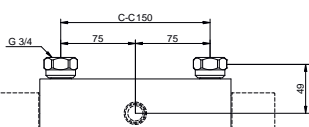

With outlet down
Matt black



GB4121840453 291 7391530076195

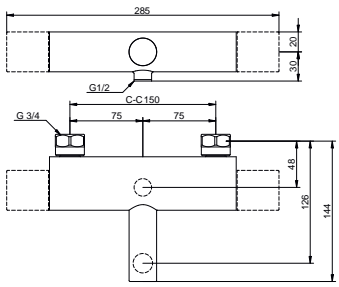

With outlet down, with fixed bathtub spout
Chrome



ART No. Price EUR
VAT 0% EAN

GB41218433

291

7391530076249



With outlet down, with fixed bathtub spout
Matt black



GB4121843353

379

7391530076256

Estetic thermostatic mixer with shower set Round and Square

- Super slim shower head Ø250 mm / 250x250 mm
- Easy clean - designed with smart nozzles that make it simple to wipe off any limescale deposits
- The head shower and shower arm are turnable and can be adjusted completely individually
- 400 mm long shower arm provides a generous shower area
- Telescopically adjustable height 770-1165 mm
- Flexible wall bracket 50-130 mm for easy installation
- 3-functional hand shower with a button
- Hand shower on glider
- 1,75 m metal braided shower hose
- Knob with clear color marking for hot and cold
- Built-in automatic hot water shut-off for scalding protection
- Block button on the temperature side at a comfort temperature of 38°C
- Safe Touch, minimizes the heat on the front of the mixer
- Reacts quickly to pressure and temperature changes in the water flow, which provides an even water temperature
- Ceramic shut-off for drip protection and long life, also simplifies use for small and weak hands
- Type-approved non-return valves in the inlets
- A smart click-on shelf is included

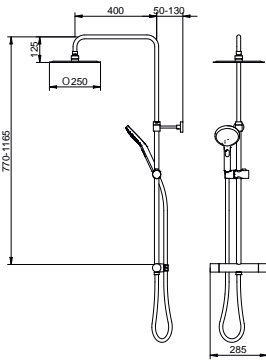

With outlet up and down, with rain shower head Round
Chrome



ART No. Price EUR
VAT 0% EAN

GB41218430

597

7391530076294



With outlet up and down, with rain shower head Round
Matt black



GB4121843053

777

7391530081342

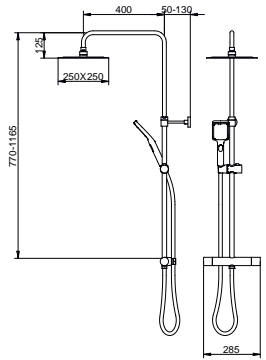

With outlet up and down, with rain shower head Square
Chrome



GB41218435

597

7391530076201



With outlet up and down, with rain shower head Square
Matt black



GB4121843553

777

7391530076218

Rain shower heads, Round and Square





- Super slim shower head Ø 250 mm / 250 x 250 mm
- Easy to clean: the design of the shower nozzles makes it simple to wipe away any limescale deposits
- The rain shower head and shower arm are turnable and can be adjusted to suit individual preferences
- A 400 mm shower arm means plenty of shower space
- Telescopically adjustable height: 840–1240 mm
- Adjustable wall fitting (50–130 mm) for simple installation
- Three-function hand shower with delightful jet patterns
- Mounted on a slider, the hand shower ensures a wonderful shower experience for users of any height
- 1.75 m chromed hose ensures consistency in the design

			ART No.	Price EUR VAT 0%	EAN
		<p>Round rain shower head without mixer</p> <p>Can be combined with all thermostatic mixers with a ½" shower connection on top</p>	GB41103230	361	7393792231190
		<p>Square rain shower head without mixer</p> <p>Can be combined with all thermostatic mixers with a ½" shower connection on top</p>	GB41103235	380	7393792231206

Shower sets, Round and Square



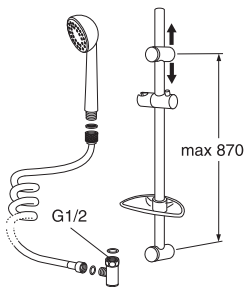







- Shower sets that combine modern, stylish design with excellent function
- Easy to clean: The design of the shower nozzles makes it simple to remove limestone deposits
- PVC-free shower hose, 1.75 m
- Wall fitting with adjustable c-c dimensions
- 3-function hand shower with push button
- Simple and flexible installation
- Can be affixed with screws or glue
- Can be combined with all Gustavsberg shower and bathtub mixers

			ART No.	Price EUR VAT 0%	EAN
		<p>Round shower set</p> <p>Chrome</p> <p>Matt black</p>	GB41103210	106	7393792232531
		<p>Square shower set</p> <p>Chrome</p>	GB41103215	111	7393792232524

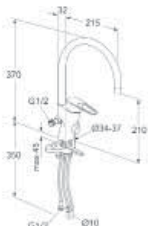
Shower sets		ART No.	Price EUR VAT 0%	EAN	
		Gustavsberg shower set with stand 720 mm, soap holder, three sprays and hose 1,75m, energy class A	GB41106250	90	7391530081021
		Fixed shower set, lenght 1070mm, Chrome/matt chrome	GB41103355	174	7393792233385
		Legionella shower set with black spiral hose and emptying valve	GB41103216	255	7393792225366

New Nautic kitchen mixer

- Energy classification A, B or C saves water and energy
- Grip-friendly lever with clear color marking for hot and cold water
- Cold-start, supplies only cold water when the lever is in straight forward position (applies to energy class B)
- Eco-flow for efficient water- and energy consumption
- Adjustable flow - facilitates, adjustable maximum flow limitation
- Soft move, ceramic seal ensures soft and precise maneuvering
- Smart inside, sustainable construction for the requirements of the future
- Adjustable max. temperature for improved scald protection
- Patented quick mounting nut for easy installation
- All components made of food graded material

			ART No.	Price EUR VAT 0%	EAN
		Nautic kitchen mixer with high spout, energy class A Lead-free	GB41206056RL	229	7391530085371
		Nautic kitchen mixer with high spout, energy class B Lead-free	GB412060560L	239	7391530085357
		Nautic kitchen mixer with high spout, energy class B Lead-free	GB41206056	198	7393792235464
		Nautic kitchen mixer with high spout, energy class B Lead-free	GB412060560	228	7393792235457
		Nautic kitchen mixer with high spout, energy class B Lead-free, Eco-Flow max 5 l/m	GB412060560B	239	7391530081946
					
		Nautic kitchen mixer with high spout, energy class A with dishwasher shut-off Lead-free	GB412060960L	288	7391530085500
		Nautic kitchen sink mixer with high spout, energy class B with dishwasher shut-off Lead-free	GB41206096	238	7393792234764
		Nautic kitchen sink mixer with high spout, energy class B with dishwasher shut-off Lead-free	GB412060960	274	7393792235419
		Nautic kitchen sink mixer with high spout, energy class B with dishwasher shut-off Lead-free, Eco-Flow max 5 l/m	GB412060960B	288	7391530081939
		Nautic kitchen sink mixer with high spout, energy class B with dishwasher shut-off Eco-Flow max 5 l/m	GB41206096B	262	7391530081922
		Nautic kitchen sink mixer with high spout, energy class B with dishwasher shut-off With G3/8" connection	GB41206096R	262	7393792234832
					
		Nautic kitchen mixer with high spout, energy class B, with connection to counter top dishwasher	GB412060966	274	7393792235433
					
		Nautic kitchen mixer with high spout D-model, energy class C, with dishwasher shut-off With G3/8" connection	GB41206097	226	7393792234757
		Nautic kitchen mixer with high spout D-model, energy class C, with dishwasher shut-off With G3/8" connection	GB41206097R	249	7393792234825
					
		Counter top dishwasher connection Smart Plus. Fits mixers with a high spout only	GB41639626 01	32	7393792232951
		Nautic kitchen mixer with low spout, energy class A Lead-free	GB412060550L	239	7391530085333
		Nautic kitchen mixer with low spout, energy class C With G3/8" connection	GB41206055	198	7393792235310
		Nautic kitchen mixer with low spout, energy class C With G3/8" connection	GB41206055R	218	7393792235327
					
		Nautic kitchen mixer with low spout, energy class A with dishwasher shut-off Lead-free	GB412060950L	250	7391530085388
		Nautic kitchen mixer with low spout, energy class C with dishwasher shut-off With G3/8" connection	GB41206095	238	7393792235297
		Nautic kitchen mixer with low spout, energy class C with dishwasher shut-off With G3/8" connection	GB41206095R	262	7393792235303
					

New Nautic Care kitchen mixer





- Energy classification A or B saves water and energy
- Grip-friendly lever with clear color marking for hot and cold water
- Laminar aerator that counteracts aerosols
- All components made of food graded material
- Cold-start, supplies only cold water when the lever is in straight forward position (applies to energy class A)
- Eco-flow for efficient water- and energy consumption
- Adjustable flow - facilitates, adjustable maximum flow
- Soft move, ceramic seal ensures soft and precise manoeuvring
- Smart inside, sustainable construction for the requirements of the future
- Adjustable max. temperature for improved scald protection
- Coated flexible water connection for improved hygiene
- Ceramic seal to prevent dripping and ensure a long service life
- Patented quick mounting nut for easy installation

			ART No.	Price EUR VAT 0%	EAN
		New Nautic Care kitchen mixer with high spout, energy class A Lead-free	GB41206056064L	275	7391530085364
		Nautic Care kitchen mixer with high spout, energy class B Lead-free	GB41206056064	262	7393792235440
		New Nautic Care kitchen mixer with high spout, energy class A with dishwasher shut-off Lead-free	GB41206096064L	331	7391530085517
		New Nautic Care kitchen mixer with low spout, energy class A Lead-free	GB41206055064L	275	7391530085340
		New Nautic Care kitchen mixer with low spout, energy class A with dishwasher shut-off Lead-free	GB41206095064L	288	7391530085395

Epic kitchen mixer

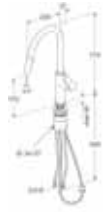
- Modern, contemporary design
- Eco-flow for efficient water- and energy consumption
- Soft move ceramic inside ensures soft and precise manoeuvring
- Swiveling 110° spout
- Adjustable max. temperature for improved scald protection
- Available in multiple color options
- Type-approved, flexible water connection for simpler installation







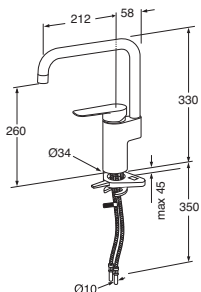

			ART No.	Price EUR VAT 0%	EAN
		Epic kitchen mixer			
		Chrome	GB41209956	203	7393792233798
		Matt black	GB41209956 53	264	7393792233811
		Brushed brass	GB41209956 24	298	7393792233804
		Epic kitchen mixer, with dishwasher shut-off			
		Chrome	GB41209996	244	7393792233828
		Matt black	GB41209996 53	317	7393792233842
		Brushed brass	GB41209996 24	358	7393792233835

		ART No.	Price EUR VAT 0%	EAN	
		Epic kitchen mixer, with extendable hand shower, without dishwasher shut-off			
		Chrome	GB41209959	254	7393792233859
		Matt black	GB41209959 53	330	7393792233873
	Brushed brass	GB41209959 24	373	7393792233866	
					
		Separate dishwasher shut-off			
		Chrome	GB41639755	58	7393792234252
		Matt black	GB41639755 53	75	7393792234276
	Brushed brass	GB41639755 24	85	7393792234269	

Atlantic kitchen mixer

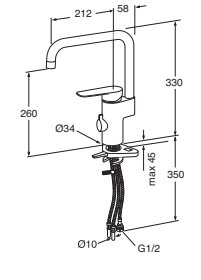
- Adjustable max. temperature for improved scald protection
- Pivoting spout 110° (0° and 60° block included)
- Eco-flow for efficient water- and energy consumption
- Cold-start, supplies only cold water when the lever is in straight forward position





- Ceramic seal to prevent dripping and ensure a long service life
- Type-approved, flexible water connection for simpler installation
- Backflow protection in accordance with SS-EN 1717 [AA]
- Also available in model containing less than 0,1% lead and with energy classification B

		ART No.	Price EUR VAT 0%	EAN	
		Atlantic kitchen mixer			
		Chrome	GB41205058	188	7393792232302
		Matt black	GB4120505853	244	7391530084886
	Atlantic kitchen mixer, lead-free and energy class B	Chrome	GB41205058 0	216	7393792232319
	  				
		Atlantic kitchen mixer with dishwasher shut-off			
		Chrome	GB41205098	226	7393792232326
		Matt black	GB4120509853	294	7391530084893
	Atlantic kitchen mixer with dishwasher shut-off, lead-free and energy class B	Chrome	GB41205098 0	260	7393792232333
	  				

Atlantic kitchen mixer with electronic shut-off valve

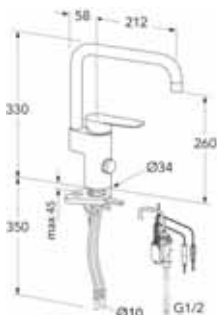
- Provides a more water secure home environment
- Contemporary, modern design in combination with excellent function
- Soft move ceramic inside ensures soft and precise maneuvering
- Pivoting spout 110° (0° and 60° block included)
- Adjustable max. temperature for improved scald protection

- Type-approved, flexible water connection for simpler installation
- Self-closing shut of valve; 3, 6 or 12 hours
- Multi-colored LED light signals function
- Including leakage detector, leakage shut-off and water alert
- Motorised valve with ceramic seal

		ART No.	Price EUR VAT 0%	EAN
		Atlantic kitchen mixer with electronic dishwasher shut-off		
		Chrome	GB41205086	848
	 			

Nordic Plus Spiralex kitchen mixer

- Two spray patterns: normal or shower spray
- Contemporary, modern design
- Soft move ceramic inside ensures soft and precise manoeuvring
- Pivoting spout
- Adjustable max. temperature for improved scald protection
- Type-approved, flexible water connection for simpler installation



Nordic Plus Spiralex kitchen mixer

Chrome

ART No. Price EUR
VAT 0% EAN

GB41203758

518

7393792233255

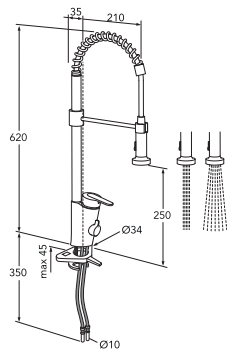

Nordic Plus Spiralex kitchen mixer with dishwasher shut-off

Chrome

GB41203798

622

7393792234283

Nordic Plus Spiralex kitchen mixer with electronic shut-off valve

- Two spray patterns: normal or shower spray
- Provides a more water secure home environment
- Contemporary, modern design, combined with excellent function
- Soft move ceramic inside ensures soft and precise manoeuvring
- Pivoting spout 110° (0° and 60°)
- Adjustable max. temperature for improved scald protection
- Type-approved, flexible water connection for simpler installation
- Self-closing shut of valve: 3, 6 or 12 hours
- Multi-colored LED light signals function
- Including leakage detector, leakage shut-off and water alert
- Motorised valve with ceramic seal



Nordic Plus Spiralex kitchen mixer with electronic dishwasher shut-off

Chrome



ART No. Price EUR
VAT 0% EAN

GB41203788





1138

7393792233262

Nordic Plus kitchen mixer

- Contemporary, modern design
- Soft move ceramic inside ensures soft and precise manoeuvring
- Pivoting spout 110° (0° and 60°)





- Adjustable max. temperature for improved scald protection
- Type-approved, flexible water connection for simpler installation

		ART No.	Price EUR VAT 0%	EAN	
		Nordic Plus kitchen mixer Chrome	GB41203756	183	7393792233231
		Nordic Plus kitchen mixer with dishwasher shut-off Chrome	GB41203796	220	7393792233248

Nordic³ kitchen mixer

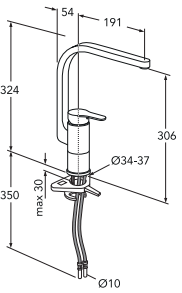
- Grip-friendly lever with clear color marking for hot and cold water
- Ceramic seal to prevent dripping and ensure a long service life
- Soft move, ceramic seal ensures soft and precise manoeuvring

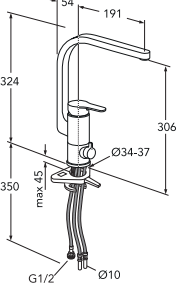
- Spout pivots through 110° (60° lock included)
- Adjustable max. temperature for improved scald protection
- All components made of food graded material
- Type approved flexible water connection for easier installation
- Backflow protection in accordance with SS-EN 1717 [AA]

		ART No.	Price EUR VAT 0%	EAN	
		Nordic ³ kitchen mixer Chrome	GB41203456	188	7393792235754
		Nordic ³ kitchen mixer with dishwasher shut-off Chrome	GB41203496	226	7393792235761

Dynamic kitchen mixer

- Pivoting spout 110°
- Ceramic cartridge ensures non-drip operation and longevity
- Adjustable max. temperature for improved scald protection

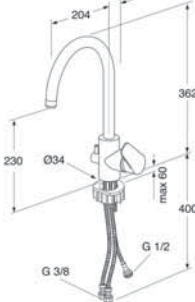

- Type approved flexible water connection for easier installation
- Backflow protection in accordance with SS-EN 1717 [AA]

		ART No.	Price EUR VAT 0%	EAN	
		Dynamic kitchen mixer Chrome	GB41204356	160	7393792232869
		Dynamic kitchen mixer with dishwasher shut-off Chrome	GB41204396	192	7393792232876

Outdoor tap

- Simple to install and serve
- Can be fitted to old, existing pipes
- Cutable in length
- Self-draining downwards, which helps protect the façade

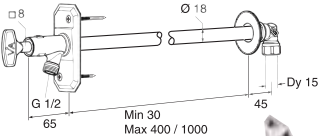
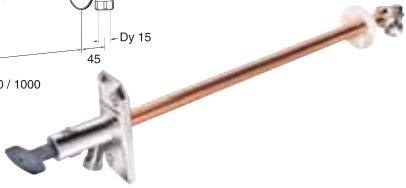
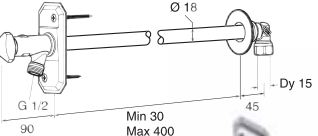
- Frost-proof – even if a hose is connected
- For wall thicknesses of max. 400 mm or max. 1000 mm
- With removable key or knob

		ART No.	Price EUR VAT 0%	EAN	
		Outdoor tap with approved non- return valve and key, self-draining For wall thicknesses of max. 30- 400 mm For wall thicknesses of max. 30- 1000 mm	FG0105060	77	7393792213141
		Outdoor tap with approved non- return valve and knob, self-draining. For wall thicknesses of max. 30- 400 mm	FG0105061	95	7393792213257



Shower doors and walls

Choose between polished or matt black profiles in a wonderful design. High quality, durable materials and smart solutions make it simple to find precisely the right shower from Gustavsberg:

- Adjustable wall profiles guarantee a level shower, even if the bathroom walls are not entirely straight.
- Doors that can open outwards or inwards save valuable space.
- Almost all our showers are designed for right- or left-handed fitting.
- Unequal-sided dimension combinations offer an optimal shower solution for all bathrooms.
- Smart elevating brackets lift the doors when you open them.

THINGS TO THINK ABOUT

Installing a new shower wall requires preparation and planning. In many bathrooms, the shower corner has to fit in with a washbasin, a toilet and sometimes a washing machine as well. So measure your shower space carefully – to make sure there are no obstacles that prevent you opening the doors. If there are, a foldable shower door can often be the solution.

FOLDABLE DOORS ARE NOT REVERSIBLE

Our folding doors are the only models that are not reversible for right-/left-hand installation. They are, however, available with uneven dimensions to the right and to the left, so it is important to measure your shower space carefully. Make sure to measure from the front, i.e. where you step into the shower. Turn the page to see the combination options.



REVERSIBLE

Shower doors, reversible for right/left-hand installation; they can open both outwards and inwards, which helps save precious space.



ELEVATING HINGE

The elevating hinge is a smart detail that lifts the shower walls 5 mm every time you open and close it. This minimises wear on both the floor and the shower doors. A practical function that provides a sense of authentic luxury.



The lack of a floor plinth makes the showers easy to use and easy to keep clean. The doors close with a tightly closing magnetic strip and have a strip against the floor that stops water splashes.

Mounting options

Our shower walls and doors can be easily combined in different dimensions and thus adapted to the specific needs of each bathroom.

* For exact mm measurements and adjustability for each door model, see the range pages.



Round shower doors fitted in a corner

Available dimensions combinations*

80x80 cm	80x100 cm	90x100 cm
80x90 cm	90x90 cm	100x100 cm



Square shower doors fitted in a corner

Available dimensions combinations*

80x80 cm	80x100 cm	90x100 cm
80x90 cm	90x90 cm	100x100 cm



Square – two straight doors fitted in a line

Available dimensions*

80 cm	90 cm	100 cm
-------	-------	--------

Combine these three door dimensions as you wish.



Square shower door fitted in a niche

Available dimensions*

80 cm	90 cm	100 cm
-------	-------	--------



Square shower wall fitted in a corner

Available dimensions*

80 cm	90 cm	100 cm
-------	-------	--------

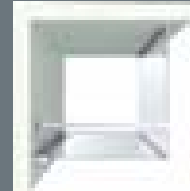

Square shower wall and Square shower door fitted in a corner

Available dimensions combinations*

80x80 cm	80x100 cm	90x100 cm
80x90 cm	90x90 cm	100x100 cm



Square bathtub door

Available dimensions*

70 cm	80 cm
-------	-------



Square folding doors fitted in a corner

Possible dimensions*

80x80 cm	90x90 cm	100x100 cm
80x90 cm	90x80 cm	100x90 cm
80x100 cm	90x100 cm	100x80 cm

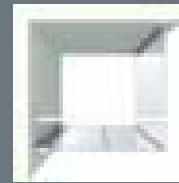

Square folding door with Square fixed wall fitted in a corner

Possible dimensions*

80x80 cm	90x90 cm	100x100 cm
80x90 cm	90x80 cm	100x90 cm
80x100 cm	90x100 cm	100x80 cm



Square folding door fitted in a niche

Possible dimensions*

80 cm	90 cm	100 cm
-------	-------	--------



Square folding door with Square shower door fitted in a corner

Possible dimensions*

80x80 cm	90x90 cm	100x100 cm
80x90 cm	90x80 cm	100x90 cm
80x100 cm	90x100 cm	100x80 cm

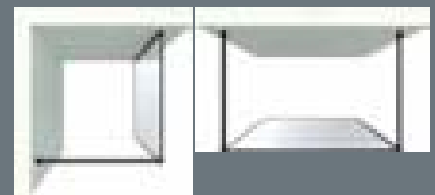

Square shower wall fitted in a corner or free to solid back wall

Possible dimensions*

80 cm	90 cm	1100 cm
120 cm	140 cm	

Square shower doors for corner fitting

- Reversible for right/left-hand installation
- Pre-fitted door profiles for quick and simple installation
- Tempered safety glass, 6 mm
- Polished chrome or matt black profiles and door handles
- Elevating hinges raise the door 5 mm on opening
- Adjustable wall profile, 20 mm, for a straight shower even with angled walls
- Opening angle: 180 degrees
- Unequal-sided dimension combinations possible
- Extension profile, 20 mm, as an optional extra
- No floor profiles, for a hygienic and easy-to-clean shower
- Space to drill holes for externally routed pipes

A x B width dimension/adjustability in mm

ART No. Price EUR
VAT 0% EAN

Polished profiles

Square shower doors, 80x80	790–810 x 790–810 mm	GB51SRDR8080CR	1016	7391530073941
Consists of:	Square shower door, 80 with magnetic profile and door handle	GB51SRDR80CR	508	7391530073521
	Square shower door, 80 with magnetic profile and door handle	GB51SRDR80CR	508	7391530073521
Square shower doors, 80x90	790–810 x 890–910 mm	GB51SRDR8090CR	1031	7391530073958
Consists of:	Square shower door, 80 with magnetic profile and door handle	GB51SRDR80CR	508	7391530073521
	Square shower door, 90 with magnetic profile and door handle	GB51SRDR90CR	525	7391530073538
Square shower doors, 80x100	790–810 x 990–1010 mm	GB51SRDR8010CR	1048	7391530073965
Consists of:	Square shower door, 80 with magnetic profile and door handle	GB51SRDR80CR	508	7391530073521
	Square shower door, 100 with magnetic profile and door handle	GB51SRDR10CR	540	7391530073545
Square shower doors, 90x90	890–910 x 890–910 mm	GB51SRDR9090CR	1048	7391530073972
Consists of:	Square shower door, 90 with magnetic profile and door handle	GB51SRDR90CR	525	7391530073538
	Square shower door, 90 with magnetic profile and door handle	GB51SRDR90CR	525	7391530073538
Square shower doors, 90x100	890–910 x 990–1010 mm	GB51SRDR9010CR	1063	7391530073989
Consists of:	Square shower door, 90 with magnetic profile and door handle	GB51SRDR90CR	525	7391530073538
	Square shower door, 100 with magnetic profile and door handle	GB51SRDR10CR	540	7391530073545
Square shower doors, 100x100	990–1010 x 990–1010 mm	GB51SRDR1010CR	1078	7391530073996
Consists of:	Square shower door, 100 with magnetic profile and door handle	GB51SRDR10CR	540	7391530073545
	Square shower door, 100 with magnetic profile and door handle	GB51SRDR10CR	540	7391530073545
Accessories: Extension profile	Allows extra adjustment of width dimension by 20 mm Possible to fit on the right- and/or left-hand side.	GB51ACCEXT	57	7391530073675



Matt black profiles

Square shower doors, 80x80	790–810 x 790–810 mm	GB51SRDR8080BL	1287	7391530078236
Consists of:	Square shower door, 80 with magnetic profile and door handle	GB51SRDR80BL	644	4062373900512
	Square shower door, 80 with magnetic profile and door handle	GB51SRDR80BL	644	4062373900512
Square shower doors, 80x90	790–810 x 890–910 mm	GB51SRDR8090BL	1307	7391530078243
Consists of:	Square shower door, 80 with magnetic profile and door handle	GB51SRDR80BL	644	4062373900512
	Square shower door, 90 with magnetic profile and door handle	GB51SRDR90BL	663	4062373900536
Square shower doors, 80x100	790–810 x 990–1010 mm	GB51SRDR8010BL	1326	7391530078250
Consists of:	Square shower door, 80 with magnetic profile and door handle	GB51SRDR80BL	644	4062373900512
	Square shower door, 100 with magnetic profile and door handle	GB51SRDR10BL	683	4062373900543
Square shower doors, 90x90	890–910 x 890–910 mm	GB51SRDR9090BL	1325	7391530078267
Consists of:	Square shower door, 90 with magnetic profile and door handle	GB51SRDR90BL	663	4062373900536
	Square shower door, 90 with magnetic profile and door handle	GB51SRDR90BL	663	4062373900536
Square shower doors, 90x100	890–910 x 990–1010 mm	GB51SRDR9010BL	1345	7391530078274
Consists of:	Square shower door, 90 with magnetic profile and door handle	GB51SRDR90BL	663	4062373900536
	Square shower door, 100 with magnetic profile and door handle	GB51SRDR10BL	683	4062373900543
Square shower doors, 100x100	990–1010 x 990–1010 mm	GB51SRDR1010BL	1365	7391530078281
Consists of:	Square shower door, 100 with magnetic profile and door handle	GB51SRDR10BL	683	4062373900543
	Square shower door, 100 with magnetic profile and door handle	GB51SRDR10BL	683	4062373900543
Accessories: Extension profile	Allows extra adjustment of width dimension by 20 mm Possible to fit on the right- and/or left-hand side.	GB51ACCEXTPBL	92	4062373900628

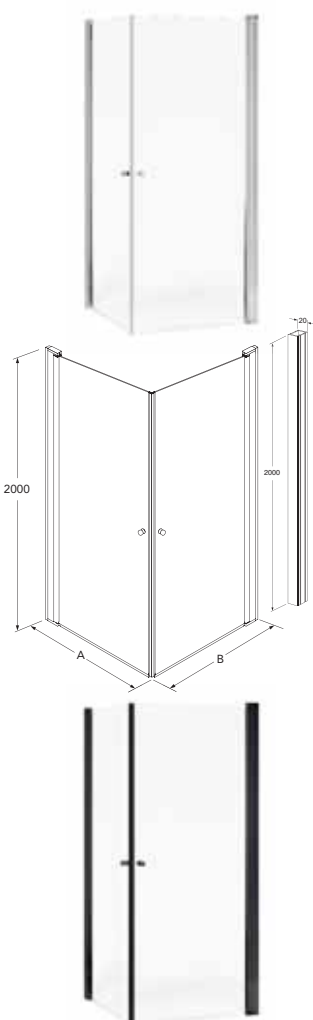

Detailed dimension sketches of each of the sizes are available at www.gustavsberg.com

We accept no liability for printing errors and reserve the right to make changes to range and specifications without notice. When making important decisions, check in advance.

Square folding doors for corner fitting

- Folding door that takes up less space
- Ideal for use where space is at a premium – as the foldability often solves the problem
- Non-reversible doors: choose from the models designed for right- and left-hand installation, respectively
- Corner configuration dimensions "Left" x "Right" viewed from in front, i.e. on your way into the shower
- Pre-fitted door profiles for quick and easy installation
- Toughened safety glass, 6 mm
- Polished chrome profiles, with the door handle integrated into the glass
- Elevating hinges lift the door 5 mm when opened
- 20 mm adjustable wall profile, which ensures a level shower even if the walls are angled
- Opening angle: 180 degrees
- Unequal-sided dimension combinations possible
- Extra-width profile, 20 mm as an optional extra
- No floor profiles means a shower that is hygienic and easy to clean, but the solution does require an incline towards the floor drain
- Space for cutting holes for external pipework



		<i>A x B width dimension/adjustability in mm</i>	<i>ART No.</i>	<i>Price EUR VAT 0%</i>	<i>EAN</i>
Polished profiles					
Square folding doors, 80x80		790–810 x 790–810 mm	GB51SRFD8080CR	1938	7391530078380
Consists of:	Square folding door, 80 with magnetic profile		GB51SRFD80LCR	951	4062373900635
	Square folding door, 80 with magnetic profile		GB51SRFD80RCR	951	4062373900666
Square folding doors, 80x90		790–810 x 890–910 mm	GB51SRFD8090CR	1952	7391530078397
Consists of:	Square folding door, 80 with magnetic profile		GB51SRFD80LCR	951	4062373900635
	Square folding door, 90 with magnetic profile		GB51SRFD90RCR	980	4062373900673
Square folding doors, 80x100		790–810 x 990–1010 mm	GB51SRFD8010CR	1966	7391530078403
Consists of:	Square folding door, 80 with magnetic profile		GB51SRFD80LCR	951	4062373900635
	Square folding door, 100 with magnetic profile		GB51SRFD10RCR	1010	4062373900680
Square folding doors, 90x90		890–910 x 890–910 mm	GB51SRFD9090CR	1966	7391530078410
Consists of:	Square folding door, 90 with magnetic profile		GB51SRFD90LCR	980	4062373900642
	Square folding door, 90 with magnetic profile		GB51SRFD90RCR	980	4062373900673
Square folding doors, 90x80		890–910 x 790–810 mm	GB51SRFD9080CR	1952	7391530078441
Consists of:	Square folding door, 90 with magnetic profile		GB51SRFD90LCR	980	4062373900642
	Square folding door, 80 with magnetic profile		GB51SRFD80RCR	951	4062373900666
Square folding doors, 90x100		890–910 x 990–1010 mm	GB51SRFD9010CR	1980	7391530078427
Consists of:	Square folding door, 90 with magnetic profile		GB51SRFD90LCR	980	4062373900642
	Square folding door, 100 with magnetic profile		GB51SRFD10RCR	1010	4062373900680
Square folding doors, 100x100		990–1010 x 990–1010 mm	GB51SRFD1010CR	1994	7391530078434
Consists of:	Square folding door, 100 with magnetic profile		GB51SRFD10LCR	1010	4062373900659
	Square folding door, 100 with magnetic profile		GB51SRFD10RCR	1010	4062373900680
Square folding doors, 100x80		990–1010 x 790–810 mm	GB51SRFD1080CR	1966	7391530078458
Consists of:	Square folding door, 100 with magnetic profile		GB51SRFD10LCR	1010	4062373900659
	Square folding door, 80 with magnetic profile		GB51SRFD80RCR	951	4062373900666
Square folding doors, 100x90		990–1010 x 890–910 mm	GB51SRFD1090CR	1980	7391530078465
Consists of:	Square folding door, 100 with magnetic profile		GB51SRFD10LCR	1010	4062373900659
	Square folding door, 90 with magnetic profile		GB51SRFD90RCR	980	4062373900673
Accessories:	Allows extra adjustment of width dimension by 20 mm		GB51ACCEXTPL	92	4062373900628
Extension profile	Possible to fit on the right- and/or left-hand side.				



Detailed dimension sketches of each of the sizes are available at www.gustavsberg.com

Round shower doors for corner fitting

- Reversible for right/left-hand installation
- Pre-fitted door profiles for quick and simple installation
- Tempered safety glass, 6 mm
- Polished chrome or matt black profiles and door handles
- Elevating hinges raise the door 5 mm on opening
- Adjustable wall profile, 20 mm, for a straight shower even with angled walls
- Opening angle: 180 degrees
- Unequal-sided dimension combinations possible
- Extension profile, 20 mm, as an optional extra
- No floor profiles, for a hygienic and easy-to-clean shower
- Space to drill holes for externally routed pipes

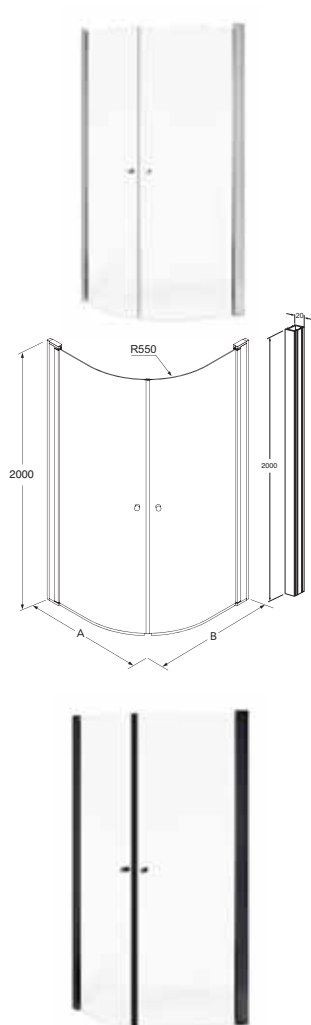

<i>A x B width dimension/adjustability in mm</i>		<i>ART No.</i>	<i>Price EUR VAT 0%</i>	<i>EAN</i>
Polished profiles				
Round shower doors, 80x80	790–810 x 790–810 mm	GB51RNRD8080CR	1117	7391530074009
Consists of:	Round shower door, 80 with magnetic profile and door handle	GB51RNRD80CR	559	7391530073552
	Round shower door, 80 with magnetic profile and door handle	GB51RNRD80CR	559	7391530073552
Round shower doors, 80x90	790–810 x 890–910 mm	GB51RNRD8090CR	1134	7391530074016
Consists of:	Round shower door, 80 with magnetic profile and door handle	GB51RNRD80CR	559	7391530073552
	Round shower door, 90 with magnetic profile and door handle	GB51RNRD90CR	577	7391530073569
Round shower doors, 80x100	790–810 x 990–1010 mm	GB51RNRD8010CR	1151	7391530074023
Consists of:	Round shower door, 80 with magnetic profile and door handle	GB51RNRD80CR	559	7391530073552
	Round shower door, 100 with magnetic profile and door handle	GB51RNRD10CR	593	7391530073576
Round shower doors, 90x90	890–910 x 890–910 mm	GB51RNRD9090CR	1151	7391530074030
Consists of:	Round shower door, 90 with magnetic profile and door handle	GB51RNRD90CR	577	7391530073569
	Round shower door, 90 with magnetic profile and door handle	GB51RNRD90CR	577	7391530073569
Round shower doors, 90x100	890–910 x 990–1010 mm	GB51RNRD9010CR	1168	7391530074047
Consists of:	Round shower door, 90 with magnetic profile and door handle	GB51RNRD90CR	577	7391530073569
	Round shower door, 100 with magnetic profile and door handle	GB51RNRD10CR	593	7391530073576
Round shower doors, 100x100	990–1010 x 990–1010 mm	GB51RNRD1010CR	1185	7391530074054
Consists of:	Round shower door, 100 with magnetic profile and door handle	GB51RNRD10CR	593	7391530073576
	Round shower door, 100 with magnetic profile and door handle	GB51RNRD10CR	593	7391530073576
Accessories: Extension profile	Allows extra adjustment of width dimension by 20 mm Possible to fit on the right- and/or left-hand side.	GB51ACCEXTTP	57	7391530073675
Matt black profiles				
Round shower doors, 80x80	790–810 x 790–810 mm	GB51RNRD8080BL	1415	7391530078298
Consists of:	Round shower door, 80 with magnetic profile and door handle	GB51RNRD80BL	708	4062373900550
	Round shower door, 80 with magnetic profile and door handle	GB51RNRD80BL	708	4062373900550
Round shower doors, 80x90	790–810 x 890–910 mm	GB51RNRD8090BL	1436	7391530078304
Consists of:	Round shower door, 80 with magnetic profile and door handle	GB51RNRD80BL	708	4062373900550
	Round shower door, 90 with magnetic profile and door handle	GB51RNRD90BL	729	4062373900567
Round shower doors, 80x100	790–810 x 990–1010 mm	GB51RNRD8010BL	1457	7391530078311
Consists of:	Round shower door, 80 with magnetic profile and door handle	GB51RNRD80BL	708	4062373900550
	Round shower door, 100 with magnetic profile and door handle	GB51RNRD10BL	750	4062373900574
Round shower doors, 90x90	890–910 x 890–910 mm	GB51RNRD9090BL	1457	7391530078328
Consists of:	Round shower door, 90 with magnetic profile and door handle	GB51RNRD90BL	729	4062373900567
	Round shower door, 90 with magnetic profile and door handle	GB51RNRD90BL	729	4062373900567
Round shower doors, 90x100	890–910 x 990–1010 mm	GB51RNRD9010BL	1478	7391530078335
Consists of:	Round shower door, 90 with magnetic profile and door handle	GB51RNRD90BL	729	4062373900567
	Round shower door, 100 with magnetic profile and door handle	GB51RNRD10BL	750	4062373900574
Round shower doors, 100x100	990–1010 x 990–1010 mm	GB51RNRD1010BL	1500	7391530078342
Consists of:	Round shower door, 100 with magnetic profile and door handle	GB51RNRD10BL	750	4062373900574
	Round shower door, 100 with magnetic profile and door handle	GB51RNRD10BL	750	4062373900574
Accessories: Extension profile	Allows extra adjustment of width dimension by 20 mm Possible to fit on the right- and/or left-hand side.	GB51ACCEXTPBL	92	4062373900628



Detailed dimension sketches of each of the sizes are available at www.gustavsberg.com

We accept no liability for printing errors and reserve the right to make changes to range and specifications without notice. When making important decisions, check in advance.

Square shower doors for niche fitting

- Reversible for right/left-hand installation
- Pre-fitted door profiles for quick and simple installation
- Tempered safety glass, 6 mm
- Polished chrome or matt black profiles and door handles
- Elevating hinges raise the door 5 mm on opening
- Adjustable wall profile, 30 mm, for a straight shower even with angled walls
- Opening angle: 180 degrees
- Extension profile, 20 mm, as an optional extra
- Space to drill holes for externally routed pipes on the door's hinged side

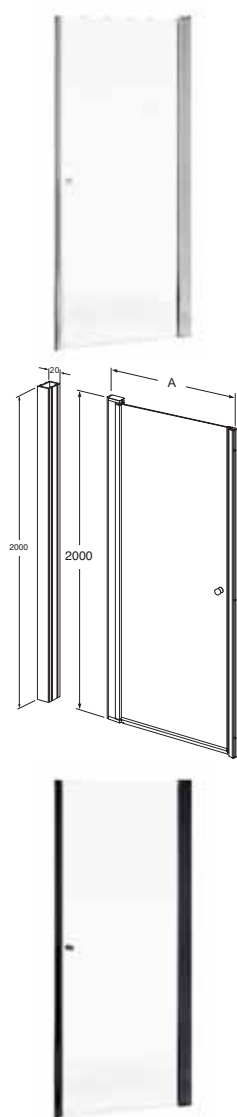

<i>A x B width dimension/adjustability in mm</i>		<i>ART No.</i>	<i>Price EUR VAT 0%</i>	<i>EAN</i>
Polished profiles				
Square shower door for niche, 80	796–826 mm	GB51SRDR80NICR	644	7391530074061
Consists of:	Square shower door, 80 with magnetic profile and door handle	GB51SRDR80CR	508	7391530073521
	Square niche profile	GB51ACCPROF	136	7391530073637
Square shower door for niche, 90	896–926 mm	GB51SRDR90NICR	659	7391530074078
Consists of:	Square shower door, 90 with magnetic profile and door handle	GB51SRDR90CR	525	7391530073538
	Square niche profile	GB51ACCPROF	136	7391530073637
Square shower door for niche, 100	996–1026 mm	GB51SRDR10NICR	675	7391530074085
Consists of:	Square shower door, 100 with magnetic profile and door handle	GB51SRDR10CR	540	7391530073545
	Square niche profile	GB51ACCPROF	136	7391530073637
Accessories: Extension profile	Allows extra adjustment of width dimension by 20 mm Possible to fit on the right- and/or left-hand side.	GB51ACCEXT	57	7391530073675
Matt black profiles				
Square shower door for niche, 80	796–826 mm	GB51SRDR80NIBL	820	7391530078359
Consists of:	Square shower door, 80 with magnetic profile and door handle	GB51SRDR80BL	644	4062373900512
	Square niche profile	GB51ACCPROFBL	176	4062373900611
Square shower door for niche, 90	896–926 mm	GB51SRDR90NIBL	839	7391530078366
Consists of:	Square shower door, 90 with magnetic profile and door handle	GB51SRDR90BL	663	4062373900536
	Square niche profile	GB51ACCPROFBL	176	4062373900611
Square shower door for niche, 100	996–1026 mm	GB51SRDR10NIBL	859	7391530078373
Consists of:	Square shower door, 100 with magnetic profile and door handle	GB51SRDR10BL	683	4062373900543
	Square niche profile	GB51ACCPROFBL	176	4062373900611
Accessories: Extension profile	Allows extra adjustment of width dimension by 20 mm Possible to fit on the right- and/or left-hand side.	GB51ACCEXTPBL	92	4062373900628

Detailed dimension sketches of each of the sizes are available at www.gustavsberg.com

Square folding doors for niche fitting

- Folding door that takes up less space
- Ideal for use where space is at a premium – as the foldability often solves the problem
- Non-reversible doors: choose from the models designed for right- and left-hand installation, respectively
- Pre-fitted door profiles for quick and easy installation
- Toughened safety glass, 6 mm
- Polished chrome profiles, with the door handle integrated into the glass
- Elevating hinges lift the door 5 mm when opened
- 25 mm adjustable wall profile, which ensures a level shower even if the walls are angled
- Opening angle: 180 degrees
- Extra-width profile, 20 mm as an optional extra
- No floor profiles means a shower that is hygienic and easy to clean, but the solution does require an incline towards the floor drain
- Space for cutting holes for external pipework

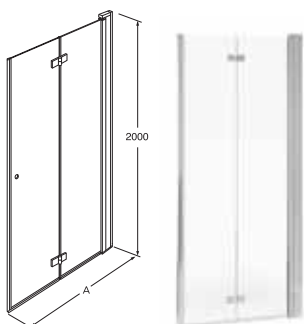
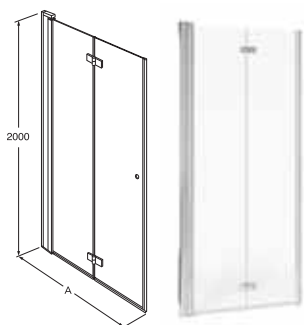

<i>A x B width dimension/adjustability in mm</i>		<i>ART No.</i>	<i>Price EUR VAT 0%</i>	<i>EAN</i>
Polished profiles, left hinged door				
Square folding door for niche, 80	802–827 mm	GB51SRFD80NILCR	1107	7391530078472
Consists of:	Square shower door, 80 with magnetic profile	GB51SRFD80LCR	951	4062373900635
	Square niche profile	GB51ACCPROF	136	7391530073637
Square folding door for niche, 90	902–927 mm	GB51SRFD90NILCR	1121	7391530078489
Consists of:	Square shower door, 90 with magnetic profile	GB51SRFD90LCR	980	4062373900642
	Square niche profile	GB51ACCPROF	136	7391530073637
Square folding door for niche, 100	1002–1027 mm	GB51SRFD10NILCR	1135	7391530078496
Consists of:	Square shower door, 100 with magnetic profile	GB51SRFD10LCR	1010	4062373900659
	Square niche profile	GB51ACCPROF	136	7391530073637
Accessories: Extension profile	Allows extra adjustment of width dimension by 20 mm Possible to fit on the right- and/or left-hand side.	GB51ACCEXT	57	7391530073675
Polished profiles, right hinged door				
Square folding door for niche, 80	802–827 mm	GB51SRFD80NIRCR	1107	7391530078502
Consists of:	Square shower door, 80 with magnetic profile	GB51SRFD80RCR	951	4062373900666
	Square niche profile	GB51ACCPROF	136	7391530073637
Square folding door for niche, 90	902–927 mm	GB51SRFD90NIRCR	1121	7391530078519
Consists of:	Square shower door, 90 with magnetic profile	GB51SRFD90RCR	980	4062373900673
	Square niche profile	GB51ACCPROF	136	7391530073637
Square folding door for niche, 100	1002–1027 mm	GB51SRFD10NIRCR	1135	7391530078526
Consists of:	Square shower door, 100 with magnetic profile	GB51SRFD10RCR	1010	4062373900680
	Square niche profile	GB51ACCPROF	136	7391530073637
Accessories: Extension profile	Allows extra adjustment of width dimension by 20 mm Possible to fit on the right- and/or left-hand side.	GB51ACCEXT	57	7391530073675

Detailed dimension sketches of each of the sizes are available at www.gustavsberg.com

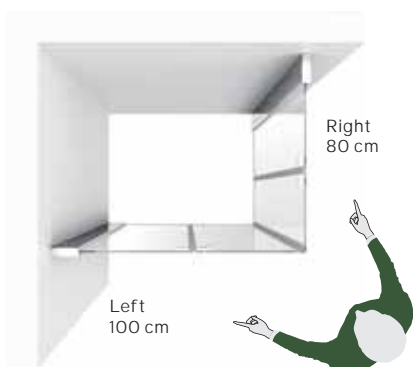

Right or left?

NON-REVERSIBLE MODEL Our folding doors are the only shower models that are not reversible for right-/left-hand installation. However, they are available in unequal dimensions on the right and left-hand sides. Here, it is important to look at things from the correct side when measuring your shower space. Make sure to measure from the front, i.e. where you step into the shower. What combination possibilities you have to choose from, see page 82.

Square shower wall

- Reversible for right-/left-hand installation
- Tempered safety glass, 6 mm
- Polished chrome or matt black profile and wall brace
- Adjustable wall profile, 20 mm, for a straight shower even with angled walls
- The brace can also be used as a shower curtain rod
- Space to drill holes for externally routed pipes

A x B width dimension/adjustability in mm

ART No.

Price EUR
VAT 0%

EAN

Polished profiles

Square shower wall, 80	792–812 mm	GB51SRWL80CR	469	7391530073606
Square shower wall, 90	892–912 mm	GB51SRWL90CR	488	7391530073613
Square shower wall, 100	992–1012 mm	GB51SRWL100CR	507	7391530073620
Accessories:				
Magnetic profile	For combination with one Square shower door. Not size specific.	GB51ACCWLMAG	45	7391530073651
Extra long brace, 1400 mm	A longer brace provides larger opening to the showespace	GB51ACCWLB14CR	265	8591019409769

Matt black profiles

Square shower wall, 80	792–812 mm	GB51SRWL80BL	536	4062373900581
Square shower wall, 90	892–912 mm	GB51SRWL90BL	558	4062373900598
Square shower wall, 100	992–1012 mm	GB51SRWL100BL	579	4062373900604
Accessories:				
Magnetic profile	For combination with one Square shower door. Not size specific.	GB51ACCWLMAGBL	81	7391530078847
Extra long brace, 1400 mm	A longer brace provides larger opening to the showespace	GB51ACCWLB14BL	265	8591019409776

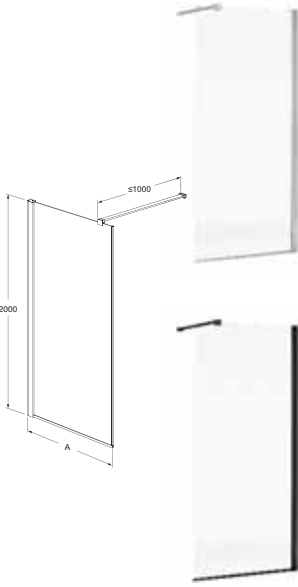

Detailed dimension sketches of each of the sizes are available at www.gustavsberg.com

Square shower wall Matt black

- Reversible for right-/left-hand installation
- Tempered safety glass, 6 mm
- Profiles and wall brace in matt black anodised aluminium
- Bars on the outside of the glass to facilitate cleaning
- Adjustable wall profile, 10 mm, for a straight shower even with angled walls
- The brace can be used as a curtain rail

A x B width dimension/adjustability in mm

ART No.

Price EUR
VAT 0%

EAN

Matt black profiles

Square shower wall, 80	780–790 mm	GB51SRWL80HBL	623	7391530074856
Square shower wall, 90	880–890 mm	GB51SRWL90HBL	688	7391530074863
Square shower wall, 100	980–990 mm	GB51SRWL100HBL	726	7391530074870
Square shower wall, 120	1180–1190 mm	GB51SRWL120HBL	817	7391530074887
Square shower wall, 140	1380–1390 mm	GB51SRWL140HBL	882	7391530074894
Accessories:				
Extra long brace, 1400 mm	A longer brace provides larger opening to the showespace	GB51ACCWLB14BL	265	8591019409776
Extra brace, 1200 mm	Needed for placement free against a wall	GB59SESP0020	63	7391530074924

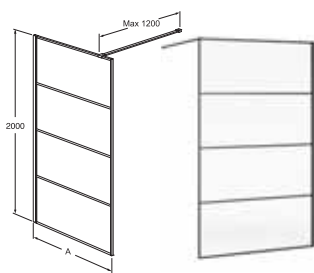

Detailed dimension sketches of each of the sizes are available at www.gustavsberg.com

Square bathtub door

- Reversible for right-/left-hand installation
- Tempered safety glass, 6 mm
- Polished chrome profile
- Elevating hinges that raise the door 5 mm on opening
- Adjustable wall profile, 20 mm, for a straight shower even with angled walls
- Opening angle, 180 degrees

A x B width dimension/adjustability in mm

ART No.

Price EUR
VAT 0%

EAN

Polished profiles

Square bathtub door, 70	690–710 mm	GB51SRBD70CR	408	7391530073583
Square bathtub door, 80	790–810 mm	GB51SRBD80CR	428	7391530073590

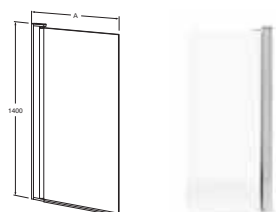

Detailed dimension sketches of each of the sizes are available at www.gustavsberg.com



Mixer and shower set

Match your new shower doors and walls with our wide range of shower mixers, shower sets and rain shower heads for a sweet, neat and functional set-up in your bathroom. No matter whether your main interest is in form, smart functions for saving water and energy or "simply" good quality, Gustavsberg lets you be price-, eco- and design-conscious at the same time.

Bathtubs

A hot bath lowers the pulse and boosts circulation in the body. Few things are as de-stressing and relaxing as slipping into a warm bath after a long, hectic – and possibly chilly – day. That's why you need to take care when choosing your tub, because the model you select will have to perform heroic deeds no other piece of furniture in your home can handle. What's most important: appearance, size or function? Or is everything equally important?

TO THINK OF

Big or small? Built-in or free-standing? In this catalogue you will find all kinds of standard bathtubs from Gustavsberg, take for example the combi-tubs, they are perfect for people who also use their bathtubs as their shower. These tubs have a flat section at the foot end, and the drain is positioned in the middle. The head end is gently angled and comfortable. Duo bathtubs are ideal for people who appreciate square design. Perfect for two people to bath together; features two sloping head.



GLAZEPLUS

Our bathtubs are available with an extra surface treatment called "glazeplus". This is a crystal-clear polymer film that protects the surface of your bathtub against dirt and limescale deposits – which facilitates cleaning and reduces the amount of detergent you need to use.



ANTI-SLIP

The bathtub is available with an anti-slip treatment where quartz sand has been burned into the enamel in an aesthetically neutral pattern. The surface counteracts the risk of slipping when entering or leaving the bathtub. Moreover, it is located at the foot end of the tub so that it does not affect the overall bathing experience.



SUPPORT HANDLES

You can order the bathtub with support handles on the rim to improve safety and ease of use.



PLUS5

An overflow outlet on the bathtub rim prevents the water from overflowing – but means a lower water level when you bathe. Gustavsberg has solved this problem with the smartest overflow outlet on the market: the plus5 system lets you raise the valve 5 cm with a simple movement – for deeper water and a more luxurious bath. An overflow outlet is an insurance requirement for fixed installation tubs in bathrooms without a floor drain.



Basin models for enamelled titanium steel bathtubs with front panel frames or feet

- Gustavsberg has many models and sizes, intended for installing with full- or half-front panels frames.
- Our tubs are made of enamelled titanium steel of the highest quality.
- The tubs are simple to install and easy to clean.
- Handles and anti-slip bottom surface treatment available

as options for a safer bath.

- Glazeplus available as an option for fast, gentle cleaning

Placement anti-slip treatment

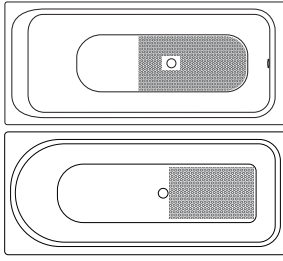

Basin models



Combi-tubs are perfect for people who also use their bathtubs as their shower. These tubs have a flat section at the foot end, and the drain is positioned in the middle. The head end is gently angled and comfortable.

Available in sizes 1500 x 700, 1570 x 700 and 1600 x 700 mm.

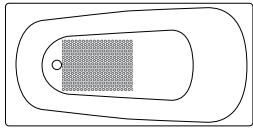

Bathtub models 1400 and 1700, and frontless tub 1571 feature a traditional basin shape. It has a depth of 420 mm, which means that it is comfortable and practical for both baths and showers.

Available in sizes 1400 x 700 and 1700 x 700 mm.

Frontless bathtub in size 1570 x 700 mm.

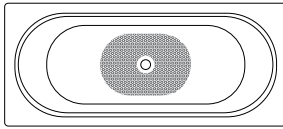

The Duo tub is designed for two people bathing at the same time with its two angled head ends and centred drain. Depth 420 mm.

Available in size 1600 x 700 mm.

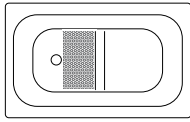

Sitting tub model 1051 is designed for people who have a really small bathroom but who cannot do without a bath. Depth of the sitting area is 310 mm. Depth of the foot area is 420 mm.

Available in size 1050 x 650 mm.

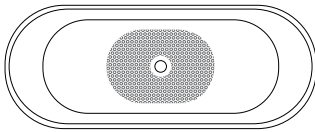

The Claw-foot bathtub features an oval basin with two enclosing head ends and a centred drain. It has a depth of 420 mm.

Available in sizes 1580 x 680 and 1680 x 730 mm.

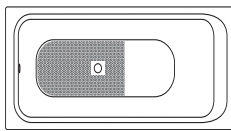

Bathtub 1300 features a traditional basin shape. It is comfortable and practical for both baths and showers, with a depth of 420 mm.

Available in size 1300 x 700 mm

Accessories

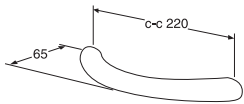

Handles

Fits all bathtubs except sitting tub 1051
Only a single handle can be fitted to bathtub models 1603, 1607 and 1707.
2 handles

NB! The bathtub must be ordered featuring holes for handles.

ART No.

Price EUR
VAT 0%

EAN

GB208B080901

480

4038565022362

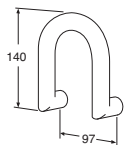

Handle, high

Fits sitting tub 1050
2 handles

NB! The bathtub must be ordered featuring holes for handles.

GB208B060901

551

4038565022355



Supplement Anti-slip Supplement Glazeplus

For art-no of antislip and glazeplus supplement, please contact:

customerservice.se@gustavsberg.com

NB! Not possible to alter, cancel or return after approved order.

Enamelled titanium steel bathtubs with full- or half-front panel frame

- Enamelled, titanium alloy sheet steel of the highest quality
- Complete with front panel frame, fitted bottom valve and drain pipe
- The front panel frame can be slid sideways and back, allowing room to route pipes along the walls
- Adjustable feet, 25 mm
- Full front panel features a slidable lower section to facilitate cleaning
- Glazeplus available as an option for simple, eco-friendly cleaning
- Front panel frame in black or white for several models

Water volume: 150 litre

Basin pictures: see page 92.

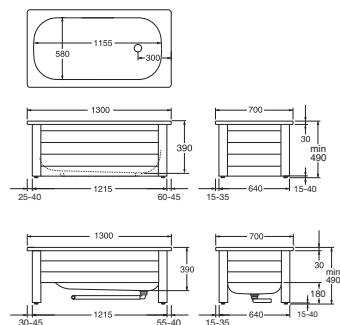

Bathtub 1300 with full-front panel frame 1300x700 mm
Without overflow hole and w/o feet, with bottom valve

White

Consists of:

Bathtub

7413 Frame incl. one full front and end panel

Bathtub 1300 with half-front panel frame 1300x700 mm
Without overflow hole and w/o feet, with bottom valve

White

Consists of:

Bathtub

6413 Frame incl. one half front and end panel



ART No.	Price EUR VAT 0%	EAN
GB211300741301	1202	7391530071978
GB2113000100	820	4038565003774
GB2174130100	382	7391530071862
GB211300641301	1130	7391530071985
GB2113000100	820	4038565003774
GB2164130100	310	7391530071923

Water volume: 155 litre

Basin pictures: see page 92.

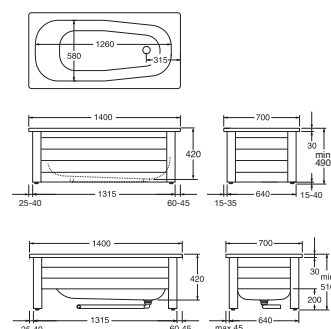

Bathtub 1400 with full-front panel frame 1400x700 mm
Without overflow hole and w/o feet, with bottom valve

White

Consists of:

Bathtub

7414 Frame incl. one full front and end panel

Bathtub 1400 with half-front panel frame 1400x700 mm
Without overflow hole and w/o feet, with bottom valve

White

Consists of:

Bathtub

6414 Frame incl. one half front and end panel



GB211400741401	1032	7391530071992
GB2114000100	650	4038565003699
GB2174140100	382	7391530071879
GB211400641401	960	7391530072005
GB2114000100	650	4038565003699
GB2164140100	310	7391530071930

Water volume: 175 litre

Basin pictures: see page 92.

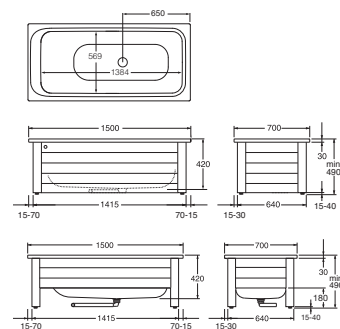

Bathtub, Combi 1504 with full-front panel frame, 1500 x 700 mm
Without overflow hole and w/o feet, with bottom valve

White

Consists of:

Bathtub

7415 Frame incl. one full front and end panel

Bathtub, Combi 1504 with half-front panel frame, 1500x700 mm
Without overflow hole and w/o feet, with bottom valve

White

Consists of:

Bathtub

6415 Frame incl. one half front and end panel



GB211504741501	1032	7391530072012
GB2115040100	650	7391530071787
GB2174150100	382	7391530071886
GB211504641501	960	7391530072029
GB2115040100	650	7391530071787
GB2164150100	310	7391530071947

Water volume: 189 litre

Basin pictures: see page 92.

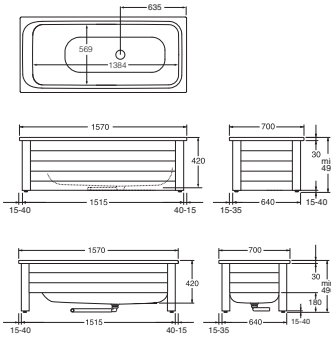

Bathtub, Combi 1574 with full-front panel frame, 1570x700 mm
Without overflow hole and w/o feet, with bottom valve

White

Black

Consists of:

Bathtub

7416 Frame incl. one full front and end panel

7416-56 Frame incl. one full front and end panel, black

Bathtub, Combi 1574 with half-front panel frame, 1570x700 mm
Without overflow hole and w/o feet, with bottom valve

White

Consists of:

Bathtub

6416 Frame incl. one half front and end panel



ART No.

Price EUR
VAT 0%

EAN

GB211574741601

1130

7391530072036

GB211574741656

1236

7391530072043

GB2115740100

748

7391530071718

GB2174160100

382

7391530071893

GB2174165600

488

7391530071909

GB211574641601

1058

7391530072050

GB2115740100

748

7391530071718

GB2164160100

310

7391530071954

Water volume: 189 litre

Basin pictures: see page 92.

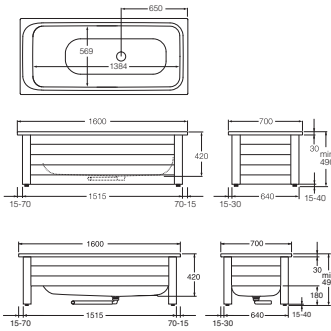

Bathtub, Combi 1604 with full-front panel frame, 1600x700 mm
Without overflow hole and w/o feet, with bottom valve

White

Black

Consists of:

Bathtub

7416 Frame incl. one full front and end panel

7416-56 Frame incl. one full front and end panel, black

Bathtub, Combi 1604 with half-front panel frame, 1600x700 mm
Without overflow hole and w/o feet, with bottom valve

White

Consists of:

Bathtub

6416 Frame incl. one half front and end panel



GB211604741601

1104

7391530072067

GB211604741656

1210

7391530072074

GB2116040100

722

7391530071640

GB2174160100

382

7391530071893

GB2174165600

488

7391530071909

GB211604641601

1032

7391530072081

GB2116040100

722

7391530071640

GB2164160100

310

7391530071954

Water volume: 186 litre

Basin pictures: see page 92.

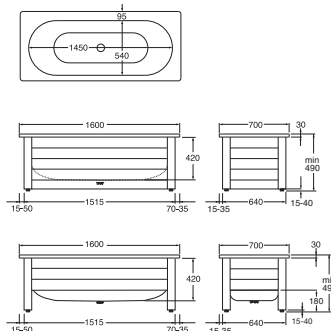

Bathtub Duo 1603 with full-front panel frame, 1600x700 mm
With equal bath sides, central bottom valve, w/o overflow hole and w/o feet

White

Black

Consists of:

Bathtub

7416 Frame incl. one full front and end panel

7416-56 Frame incl. one full front and end panel, black

Bathtub Duo 1603 with half-front panel frame, 1600x700 mm
With equal bath sides, central bottom valve, w/o overflow hole and w/o feet

White

Consists of:

Bathtub

6416 Frame incl. one half front and end panel



GB211603741601

1136

7391530072104

GB211603741656

1242

7391530072111

GB2116030100

754

4038565003958

GB2174160100

382

7391530071893

GB2174165600

488

7391530071909

GB211603641601

1064

7391530072128

GB2116030100

754

4038565003958

GB2164160100

310

7391530071954

Water volume: 190 litre

Basin pictures: see page 92.

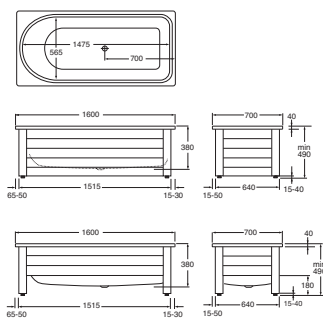

Bathtub, Combi 1607 with full-front panel frame, 1600 x 700 mm
With level shower area, bottom valve, w/o overflow hole and w/o feet

White

Black

Consists of:

Bathtub

7416 Frame incl. one full front and end panel

7416-56 Frame incl. one full front and end panel, black

Bathtub, Combi 1607 with half-front panel frame, 1600x700 mm
With level shower area, bottom valve, w/o overflow hole and w/o feet

White

Consists of:

Bathtub

6416 Frame incl. one half front and end panel



ART No.	Price EUR VAT 0%	EAN
GB211607741601	2033	7391530072135
GB211607741656	2139	7391530072142
GB2116070100	1651	7391530061887
GB2174160100	382	7391530071893
GB2174165600	488	7391530071909
GB211607641601	1961	7391530072159
GB2116070100	1651	7391530061887
GB2164160100	310	7391530071954

Water volume: 190 litre

Basin pictures: see page 92.

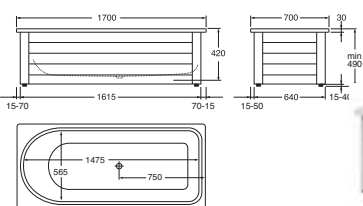

Bathtub, Combi 1707 with full-front panel frame, 1700 x 700 mm
With level shower area, bottom valve, w/o overflow hole and w/o feet, with bottom valve

White

Consists of:

Bathtub

7417 Frame incl. one full front and end panel



GB211707741701	2062	7391530072166
GB2117070100	1651	7391530061894
GB2174170100	411	7391530071916

Water volume: 190 litre

Basin pictures: see page 92.

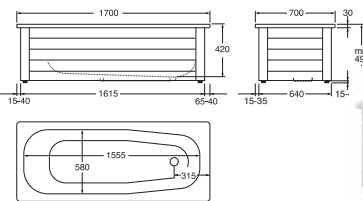

Bathtub 1700 with full-front panel frame, 1700 x 700 mm
Without overflow hole and w/o feet, with bottom valve

White

Consists of:

Bathtub

7417 Frame incl. one full front and end panel



GB211700741701	1045	7391530072098
GB2117000100	634	4038565003323
GB2174170100	411	7391530071916

Water volume: 106 litre

Basin pictures: see page 92.

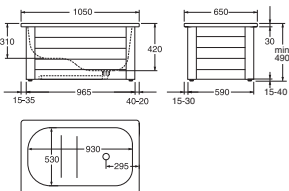

Sitting tub 1051 with full-front panel frame, 1050 x 650 mm
Without overflow hole and w/o feet, with bottom valve

White

Consists of:

Bathtub

7410 Frame incl. one full front and end panel



GB211051741001	1213	7391530071961
GB2110510100	869	4038565003866
GB2174100100	344	7391530071855

Frontless bathtubs in enamelled titanium steel

- Enamelled, titanium alloy sheet steel of the highest quality
- Enamelled exterior
- Without front panel for easier cleaning
- Delivered complete with fitted bottom valve and drain pipe
- Adjustable feet, 25 mm
- Anti-slip treated bottom surface available as an option for a safer tub

Water volume: 186 litre

Basin pictures: see page 92.

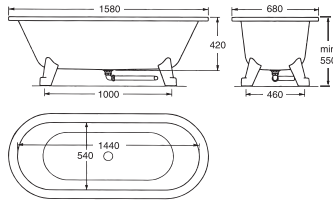

Claw-foot bathtub 6316 with feet, 1580 x 680 mm

White bathtub and feet, chromed bottom valve, white drain pipe

Claw-foot bathtub 6316 without feet, 1580x680 mm

White bathtub without feet*, chromed bottom valve, white drain pipe

Black bathtub without feet*, chromed bottom valve, white drain pipe

**) Choose feet in your choice of colour to complete the set-up.*

Complementary feet

NB! Remember to order two pairs per tub

White, pair

Black, pair



ART No.

Price EUR
VAT 0%

EAN

GB2063160101

1685

4038565006713

GB2063160001

1508

4038565006839

GB2063165601

1964

4038565006720

GB2921200353

139

7391530033549

GB2921200359

164

7391530060194

Water volume: 209 litre

Basin pictures: see page 92.

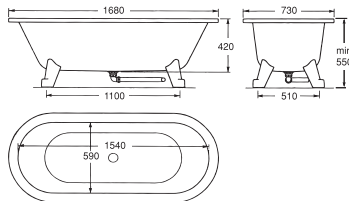

Claw-foot bathtub 6368 with feet, 1680 x 730 mm

White bathtub and feet, chromed bottom valve, white drain pipe

Claw-foot bathtub 6368 without feet, 1680 x 730 mm

White bathtub without feet*, chromed bottom valve, white drain pipe

Black bathtub without feet*, chromed bottom valve, white drain pipe

**) Choose feet in your choice of colour to complete the set-up.*

Complementary feet

NB! Remember to order two pairs per tub

White, pair

Black, pair



GB2063680101

1755

4038565006768

GB2063680001

1584

4038565006751

GB2063685601

2098

4038565006775

GB2921200353

139

7391530033549

GB2921200359

164

7391530060194

Basin models for enamelled titanium steel bathtubs for tiling in

- Gustavsberg has a wide range of models and sizes intended for tiling in
- Our tubs are made of enamelled titanium steel of the highest quality
- Handles and anti-slip bottom surface treatment available as options for a safer bath



- Glazeplus available as an option for easy, eco-friendly cleaning

Placement anti-slip treatment

Basin models

		<p>Tiling-in bathtubs 2940, 2941, 2942 and 2945 feature a traditional basin shape. This basin model is comfortable and practical for both baths and showers and is available in several sizes. Depth 420 mm. <i>Available in sizes 1400-1700 x 700 mm.</i></p>
		<p>Tiling-in bathtubs Combi 3410 and 3411 are perfect for people who want to use their bathtub as a shower as well. The tub features a generous flat area in the foot end for showering and a centred drain. The head end is sloped for a very comfortable bath. Depth 420 mm. <i>Available in sizes 1600 x 700 and 1700 x 700 mm.</i></p>
		<p>Tiling-in bathtubs, Duo 1220 and 1380 designed for two people bathing at the same time. It has two sloping head ends and a centred drain. Depth 420 mm. <i>Available in sizes 1600 x 700 and 1700 x 750.</i></p>
		<p>Tiling-in bathtubs 6830 and 6831 Ideal for people who have plenty of space and appreciate square design. Perfect for two people to bath together; features two sloping head ends and a centred drain. Extra deep 450 mm. <i>Available in sizes 1800 x 800 and 1900 x 900 mm.</i></p>
		<p>Tiling-in bathtubs, Offset 2570 and 2580 are available in left- and right-hand models. The bath is mainly designed for small bathrooms. Depth 420 mm. <i>Available in size 1570 x 700 mm.</i></p>

Accessories

	ART No.	Price EUR VAT 0%	EAN
  <p>Supplement Anti-slip Supplement Glazeplus <i>For art-no of antislip and glazeplus supplement, please contact: customerservice.se@gustavsberg.com</i> <i>NB! Not possible to alter, cancel or return after approved order.</i></p>			



PLUS5

An overflow outlet on the bathtub rim prevents the water from overflowing – but means a lower water level when you bathe. Gustavsberg has solved this problem with the smartest overflow outlet on the market: the Plus5 system lets you raise the valve 5 cm with a simple movement – for deeper water and a more luxurious bath. An overflow outlet is an insurance requirement for fixed installation tubs in bathrooms without a floor drain.











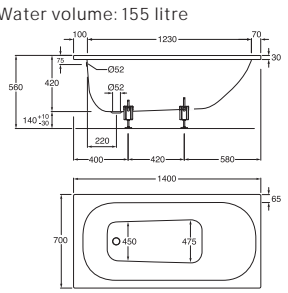



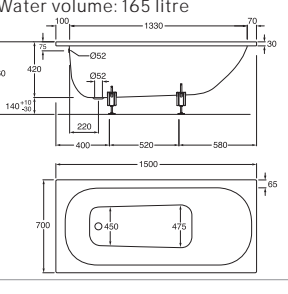



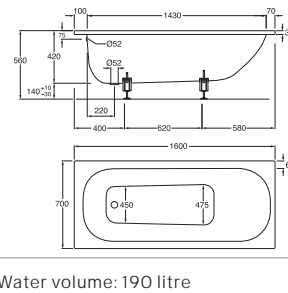



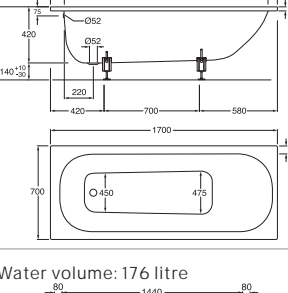

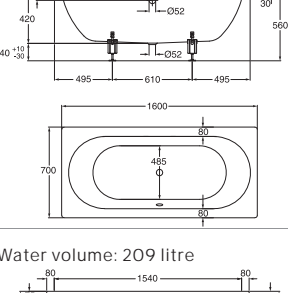

5 CM MEANS A LOT

With overflow outlet Plus 5 you can have a deeper and more enjoyable bathing experience.

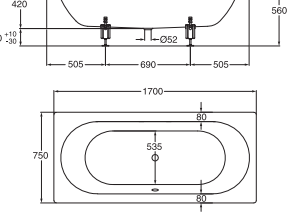
Enamelled titanium steel bathtubs for tiling-in

- Enamelled, titanium alloy sheet steel of the highest quality
- With hole for overflow outlet fitting
- Add a feet to complete the setup
- Choose an overflow outlet system: "standard" or "plus5" for a higher water level.
- All tubs feature a soundproofing mat on the underside to make your bath experience
- Handles and anti-slip bottom surface treatment available as options for a safer tub
- Glazeplus available as an option for easy and eco-friendly cleaning
- Rim-mounted mixer with filling via spout or overflow outlet as optional extra

			ART No.	Price EUR VAT 0%	EAN	
<p>Water volume: 155 litre</p> 			Tiling-in bathtub, 2940, 1400x700 mm			
			Without feet, with hole for overflow outlet	GB2082940100	683	7391530080505
			Feet for tiled-in bathtub	GB208B231500	142	4038565006850
			Overflow outlet system, Standard	GB2924300157	250	7391530085609
			Overflow outlet system, Plus5	GB208B619901	325	4038565077522
						
<p>Water volume: 165 litre</p> 			Tiling-in bathtub, 2941, 1500x700 mm			
			Without feet, with hole for overflow outlet	GB2082941100	544	7391530080581
			Feet for tiled-in bathtub	GB208B231500	142	4038565006850
			Overflow outlet system, Standard	GB2924300157	250	7391530085609
			Overflow outlet system, Plus5	GB208B619901	325	4038565077522
						
<p>Water volume: 178 litre</p> 			Tiling-in bathtub, 2942, 1600x700 mm			
			Without feet, with hole for overflow outlet	GB2082942100	544	7391530080666
			Feet for tiled-in bathtub	GB208B231500	142	4038565006850
			Overflow outlet system, Standard	GB2924300157	250	7391530085609
			Overflow outlet system, Plus5	GB208B619901	325	4038565077522
						
<p>Water volume: 190 litre</p> 			Tiling-in bathtub, 2945, 1700x700 mm			
			Without feet, with hole for overflow outlet	GB2082945100	619	7391530080741
			Feet for tiled-in bathtub	GB208B231500	142	4038565006850
			Overflow outlet system, Standard	GB2924300157	250	7391530085609
			Overflow outlet system, Plus5	GB208B619901	325	4038565077522
						
<p>Water volume: 176 litre</p> 			Tiling-in bathtub, Duo 1220, 1600x700 mm			
			Without feet, with hole for overflow outlet	GB2081220100	1324	4038565009189
			Feet for tiled-in bathtub	GB208B231500	142	4038565006850
			Overflow outlet system, Standard	GB2924300157	250	7391530085609
			Overflow outlet system, Plus5	GB208B619901	325	4038565077522
						
<p>Water volume: 209 litre</p> 			Tiling-in bathtub, Duo 1380, 1700x750 mm			
			Without feet, with hole for overflow outlet	GB2081380100	1324	4038565000636
			Feet for tiled-in bathtub	GB208B231500	142	4038565006850
			Overflow outlet system, Standard	GB2924300157	250	7391530085609
			Overflow outlet system, Plus5	GB208B619901	325	4038565077522
						

		ART No.		Price EUR	EAN
				VAT 0%	
<p>Water volume: 189 litre</p>		<p>Tiling-in bathtub, Combi 3410, 1600x700 mm</p> <p>Without feet, with hole for overflow outlet</p> <p>Feet for tiled-in bathtub</p> <p>Overflow outlet system, Plus5</p>	<p>GB2083410100</p> <p>GB208B231500</p> <p>GB208B619901</p>	<p>1082</p> <p>142</p> <p>325</p>	<p>4038565021754</p> <p>4038565006850</p> <p>4038565077522</p>
<p>Water volume: 201 litre</p>		<p>Tiling-in bathtub, Combi 3411, 1700x700 mm</p> <p>Without feet, with hole for overflow outlet</p> <p>Feet for tiled-in bathtub</p> <p>Overflow outlet system, Plus5</p>	<p>GB2083411100</p> <p>GB208B231500</p> <p>GB208B619901</p>	<p>1082</p> <p>142</p> <p>325</p>	<p>4038565021761</p> <p>4038565006850</p> <p>4038565077522</p>
<p>Water volume: 250 litre</p>		<p>Tiling-in bathtub, Duo 6830, 1800x800 mm</p> <p>Without feet, with hole for overflow outlet</p> <p>Feet for tiled-in bathtub</p> <p>Overflow outlet system, Standard</p> <p>Overflow outlet system, Plus5</p>	<p>GB2086830100</p> <p>GB208B231500</p> <p>GB2924300157</p> <p>GB208B619901</p>	<p>1788</p> <p>142</p> <p>250</p> <p>325</p>	<p>4038565007673</p> <p>4038565006850</p> <p>7391530085609</p> <p>4038565077522</p>
<p>Water volume: 280 litre</p>		<p>Tiling-in bathtub, Duo 6831, 1900x900 mm</p> <p>Without feet, with hole for overflow outlet</p> <p>Feet for tiled-in bathtub</p> <p>Overflow outlet system, Standard</p> <p>Overflow outlet system, Plus5</p>	<p>GB2086831100</p> <p>GB208B231500</p> <p>GB2924300157</p> <p>GB208B619901</p>	<p>2046</p> <p>142</p> <p>250</p> <p>325</p>	<p>4038565007468</p> <p>4038565006850</p> <p>7391530085609</p> <p>4038565077522</p>
<p>Water volume: 174 litre</p>		<p>Tiling-in bathtub, Offset 2570, 1570x700 mm</p> <p>Without feet, with hole for overflow outlet. Left</p> <p>Feet for tiled-in bathtub</p> <p>Overflow outlet system, Standard</p> <p>Overflow outlet system, Plus5</p>	<p>GB2082570100</p> <p>GB208B231500</p> <p>GB2924300157</p> <p>GB208B619901</p>	<p>1378</p> <p>142</p> <p>250</p> <p>325</p>	<p>4038565000230</p> <p>4038565006850</p> <p>7391530085609</p> <p>4038565077522</p>
<p>Water volume: 174 litre</p>		<p>Tiling-in bathtub, Offset 2580, 1570x700 mm</p> <p>Without feet, with hole for overflow outlet. Right</p> <p>Feet for tiled-in bathtub</p> <p>Overflow outlet system, Standard</p> <p>Overflow outlet system, Plus5</p>	<p>GB2082580100</p> <p>GB208B231500</p> <p>GB2924300157</p> <p>GB208B619901</p>	<p>1378</p> <p>142</p> <p>250</p> <p>325</p>	<p>4038565000254</p> <p>4038565006850</p> <p>7391530085609</p> <p>4038565077522</p>

Accessories

Our bathroom accessories are created to provide long, faithful service in a humid environment. The units follow the same refined, Scandinavian design idiom as other products from Gustavsberg, so you don't have to scrimp on quality, function or form when applying your own personal style to your bathroom. Take a little time to choose handles and knobs for your drawers and cabinets, as they play a significant role in the overall impression. To see our full range of handles and knobs, please turn to the furniture pages. Several of the knobs can also be used as towel hooks on walls.

TO THINK OF

Gustavsberg supplies a well thought-out selection of accessories. Always go for quality that lasts and design that you will enjoy for years and years. And make sure to seal all holes and cavities in bathroom walls thoroughly with silicone. Make sure not to damage the damp course in your bathroom. If you drill any holes, make sure to seal them tightly. Ask your reseller or fitter about the conditions that apply to your wall material. Plan carefully, and position your accessories with care.











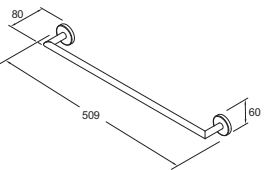

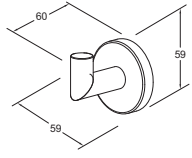

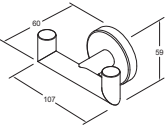
Bathroom accessories

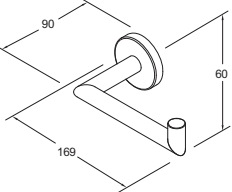

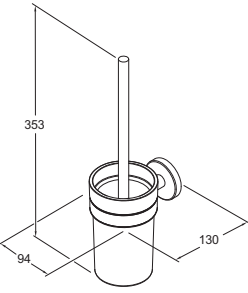



Round

- Design featuring rounded lines
- Chromed surface finish
- Can be fitted with screws or glue

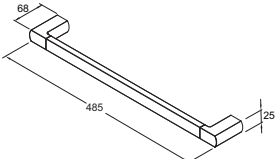
			ART No.	Price EUR VAT 0%	EAN
		Round towel rail 450 mm Chrome	GB41103701	45	7393792233972
		Round towel hanger hook Chrome	GB41103704	18	7393792233989
		Round double towel hanger hook Chrome	GB41103705	29	7393792234221
		Round toilet paper holder Chrome	GB41103707	41	7393792233996
		Round toilet paper holder Chrome	GB41103710	62	7393792234009
		Supplements Spare brush	GB41639746 01	10	7393792234238

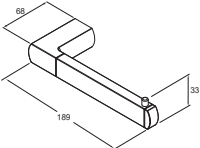
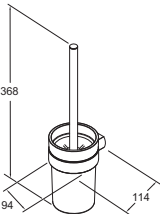

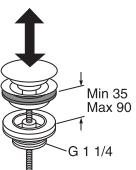

Bathroom accessories Square

- Design distinguished by straight lines and rounded corners
- Fits well in style to most bathroom collections
- Material: solid brass
- Available in different surface finishes

			ART No.	Price EUR VAT 0%	EAN
		Square towel rail 450 mm Chrome Matt black Brushed brass	GB41103901 GB41103901 53 GB41103901 24	96 125 141	7393792234016 7393792234054 7393792234092
		Square towel hanger hook Chrome Matt black Brushed brass	GB41103904 GB41103904 53 GB41103904 24	20 26 29	7393792234023 7393792234061 7393792234108
		Square toilet paper holder Chrome Matt black Brushed brass	GB41103907 GB41103907 53 GB41103907 24	47 61 69	7393792234030 7393792234078 7393792234115
		Square toilet brush and holder Chrome Matt black Brushed brass Supplements Spare brush	GB41103910 GB41103910 53 GB41103910 24 GB41639746 01	77 100 113 10	7393792234047 7393792234085 7393792234122 7393792234238
		Push-down valve Chrome Matt black Brushed brass	GB41636575 01 GB41636575 53 GB41636575 24	38 57 94	7393792214308 7393792234214 7393792234207

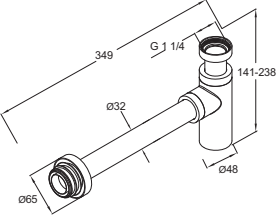
Water traps for washbasins

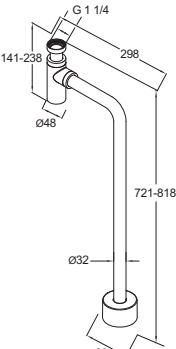
- Adjustable height and depth
- Available in different surface finishes
- Suit all washbasins in our range

			ART No.	Price EUR VAT 0%	EAN
		Water trap for wall connection Chrome Matt black Brushed brass	GB41109938 GB41109938 53 GB41109938 24	75 150 150	7393792234139 7393792234146 7393792234153
		Water trap for floor connection Chrome Matt black Brushed brass	GB41109939 GB41109939 53 GB41109939 24	103 204 204	7393792234160 7393792234177 7393792234184





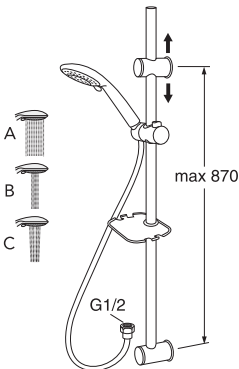
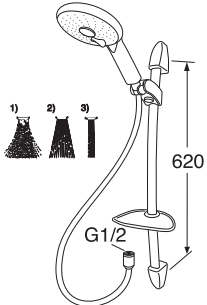
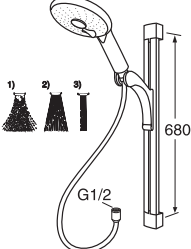
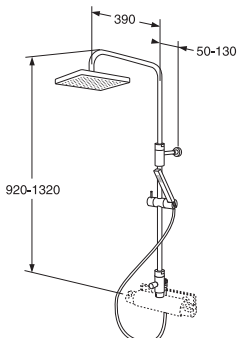
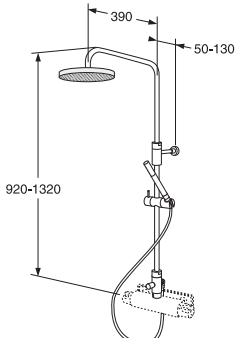

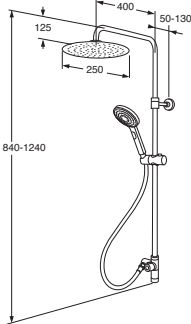
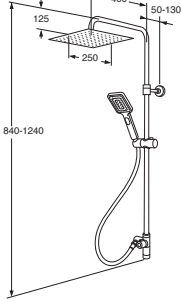
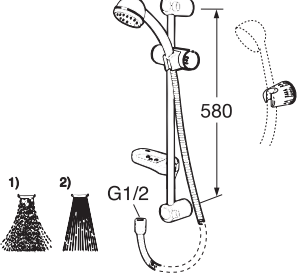
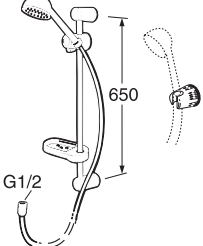



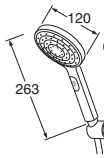

Spare parts

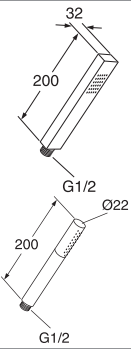
Showersets spare parts

		ART No.	Price EUR VAT 0%	EAN
	Gustavsberg shower set 1103250			
	Handshower with three sprays, chrome	GB41638725 01	33	7393792227742
	Hose 1,75 m, chrome	GB41636266 00	47	7393792208666
	Showerslider, chrome	GB41638726 01	41	7393792227759
	Wall brackets (2 pcs), chrome	GB41638727 02	36	7393792227766
	Soap holder, transparent	GB41638728 01	24	7393792227773
	Dynamic			
	Handshower with three sprays, chrome	GB41637562	70	7393792219754
	Coloric			
	Handshower with three sprays, chrome	GB41637562	70	7393792219754
	Hose 1,75 m, chrome	GB41636266 00	47	7393792208666
	G1			
	Handshower, chrome	GB41638467	56	7393792226424
	Hose 1,75 m, chrome	GB41636266 00	47	7393792208666
	Set for side mount, chrome	GB41638464	52	7393792226394
	Wall bracket, chrome	GB41638466	28	7393792226417
	Diverter, chrome	GB41638465	70	7393792226400
	Showerslider, chrome	GB41638472	38	7393792226462
	G2			
	Handshower, chrome	GB41638468	50	7393792226431
	Hose 1,75 m, chrome	GB41636266 00	47	7393792208666
	Set for side mount, chrome	GB41638464	52	7393792226394
	Wall bracket, chrome	GB41638466	28	7393792226417
	Diverter, chrome	GB41638465	70	7393792226400
	Showerslider, chrome	GB41638472	38	7393792226462

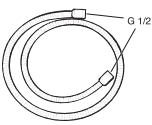

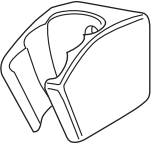
		ART No.	Price EUR VAT 0%	EAN
	G3			
	Handshower Round, chrome	GB41639440	50	7393792231466
	Hose 1,75 m, chrome	GB41636266 00	47	7393792208666
	Shower bar - extension 1060 mm, chrome	GB41639512	81	7393792231824
	Wall bracket, chrome	GB41639444	65	7393792231503
	Diverter, chrome	GB41639439	70	7393792231459
	Showerslider, chrome	GB41639445	35	7393792231510
	Shower head Round, chrome	GB41639442	199	7393792231480
Spare part seals kit	GB41639446	27	7393792231527	
	G4			
	Handshower Square, chrome	GB41639441	50	7393792231473
	Hose 1,75 m, chrome	GB41636266 00	47	7393792208666
	Shower bar - extension 1060 mm, chrome	GB41639512	81	7393792231824
	Wall bracket, chrome	GB41639444	65	7393792231503
	Diverter, chrome	GB41639439	70	7393792231459
	Showerslider, chrome	GB41639445	35	7393792231510
	Shower head Square, chrome	GB41639443	239	7393792231497
Spare part seals kit	GB41639446	27	7393792231527	
	Nordic Plus			
	Handshower with two sprays, chrome	GB41636265 00	49	7393792208635
	Hose 1,75 m, chrome	GB41636266 00	47	7393792208666
Soap holder, transparent	GB41636264 44	15	7393792215619	
	Nordic			
	Handshower, chrome	GB41636261 00	41	7393792208543
	Hose 1,75 m, chrome	GB41636266 00	47	7393792208666
	Showerslider, chrome	GB41636255 00	24	7393792210638
	Wall brackets (2 pcs), chrome	GB41636254 00	29	7393792210683
Soap holder, transparent	GB41636264 44	15	7393792215619	

Hand showers and handsprays



			ART No.	Price EUR VAT 0%	EAN
		Round hand shower 3-function hand shower with push button Chrome	GB41639440	50	7393792231466
		Matt black	GB41639440 53	193	7393792233668
		Square hand shower 3-function hand shower with push button Chrome	GB41639441	50	7393792231473
		Matt black	GB41639441 53	75	7393792233675
		Nautic hand shower, 3-function hand shower with three sprays Chrome	GB41638725 01	33	7393792227742
		G1 hand shower Single function hand shower	GB41638467	56	7393792226424
		G2 hand shower Single function hand shower	GB41638468	50	7393792226431
		Selfclosing handspray for washbasin, bidet and kitchen mixers Chrome	GB41633860 33	28	7393792218412
 G1/2		Selfclosing brush White	GB41633861 25	81	7393792219013
		Hose Chrome, covered with plastic, lenght 1,75m	GB41636263 00	21	7393792208598
		Chrome, covered with plastic, lenght 2,0m	GB41636263 0020	24	7393792220484
		Chrome, lenght 1,75m	GB41636266 00	47	7393792208666
		Matt black, lenght 1,75m	GB41637572 53	56	7393792233651
		Wall bracket for handspray with 3-positions Chrome	GB41637575	15	7393792219792
		Handshower set for wallmounted mixers Chrome	GB41634210	85	7393792200707

Levers			ART No.	Price EUR VAT 0%	EAN
		Nordic Lever after 2002	GB41636617 01	31	7393792213950
		Nautic Lever	GB41637250	40	7393792219266
		Logic Lever Chrome	GB41638514 01	35	7393792227599
		Coloric Lever for washbasin mixer Lever for bath and shower mixer	GB41637406 GB41637407	50 50	7393792221788 7393792221795
		Estetic Lever Chrome Lever Matte Black	GB41639332 01 GB41639332 53	69 116	7393792230896 7393792232968
		Nordic3 Lever	GB41639062 01	28	7393792229470
		NordicPlus Lever	GB41639510	28	7393792232029
		Nordic for disabled mixer Lever 160mm	GB41635430 01	48	7393792206648
		Nautic for disabled mixer Lever 160mm Lever 160mm painted red-blue	GB41637360 01 GB41637363 01	50 52	7393792217910 7393792226684
		New Nautic for disabled mixer Lever 160mm painted red-blue	GB41639801 01	52	7393792235792

Spouts



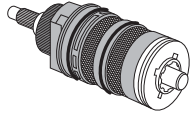

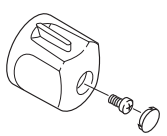
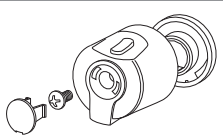
		ART No.	Price EUR VAT 0%	EAN
	Diverter spout that changes the flow of water between hose or spout			
	Chrome	GB41650247	65	7391530077062
	Matt black	GB4165024753	81	7391530077079
	Swivel spout. Possible to lock position			
	Chrome 85 mm	GB41650279	52	7391530080031
	Chrome 150 mm	GB41650282	58	7391530080048
	Chrome 250 mm	GB41650285	70	7391530080055
	Chrome 350 mm	GB41650288	80	7391530080062
	Fixed spout with self retracting pull diverter			
	Chrome	GB41650320	111	7391530080116

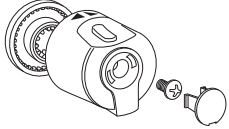
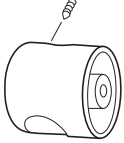
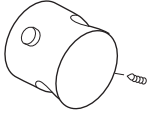
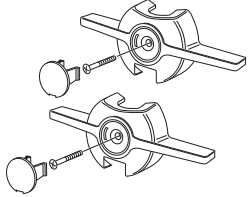
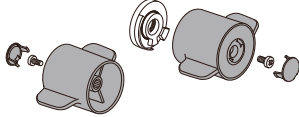

Cartridges, spareparts for thermostatic mixers

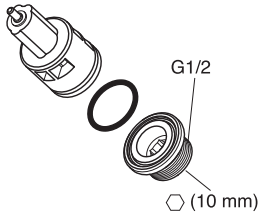
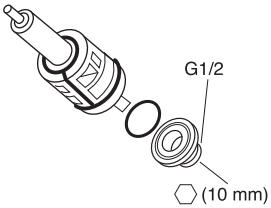
	Cartridge Cartridge (ecotemp included) Soft closing Skandic 03 mini Coloric	GB41635676 01 GB41634650 01 GB41636654 01 GB41637415	36 48 41 26	7393792210041 7393792204514 7393792219709 7393792221412
	Cartridge for thermostatic mixers from 01.05.2010	GB41638334 01	63	7393792225861
	Headpart ceramic cartridge for flow for thermostatic mixers until 31.01.2024 Ceramic	GB41634035 01	21	7393792203760
	Non-return valve with filter for thermostatic mixers 2pcs in packet	GB41632698 02	16	7393792207041
	Nordic flow control knob (from 2004 - 31.01.2024) Chrome	GB41636479 01	18	7393792213967
	Nordic temperature control knob (from 2004 - 31.01.2024) Chrome	GB41636480 01	23	7393792213974
	Nautic flow control knob until 31.01.2024 Chrome	GB41637804 01	18	7393792220170

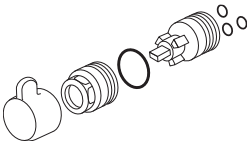

		ART No.	Price EUR VAT 0%	EAN
	Nautic temperature control knob until 31.01.2024 Chrome	GB41637810 01	20	7393792220118
	Skandic O3 flow control knob Chrome	GB41636465 01	69	7393792214230
	Skandic O3 temperature control knob Chrome	GB41636460 01	67	7393792214247
	Nautic flow and temperature control handle until 31.01.2024 Chrome	GB41637840 02	16	7393792220088
	Grey, flow side of mixer	GB4165022101	20	7391530082387
	Grey, temperature side of mixer	GB4165022301	30	7391530082394

Other spare parts

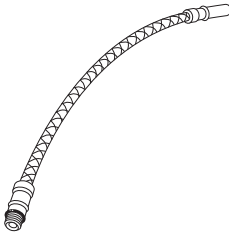
		ART No.	Price EUR VAT 0%	EAN
	Diverter for Coloric bath mixer Chrome	GB41637416	43	7393792221771
	Diverter Chrome	GB41636577 01	20	7393792217354
	Diverter Chrome	GB41634799 0001	18	7393792204811
	Inlet nipple for mixers with return valve Chrome	GB41634756 01	19	7393792216494
	Ejector	GB41634213	45	7393792219723

		ART No.	Price EUR VAT 0%	EAN	
	Aerator				
	For bathtub mixers	GB41634555 01	19	7393792209946	
	For kitchen , bidet and spouts	GB41630129 01	21	7393792209250	
	For kitchen mixers, casted spouts and washbasin mixers	GB41630131 01	15	7393792209939	
	For Skandic O3 kitchen mixers to 2007 05	GB41636437 01	43	7393792216814	
	For Skandic O3 kitchen mixers from 2007 05 and Coloric washbasin mixers	GB41637337 01	31	7393792219921	
	For Skandic O3 mini mixers	GB41636912 01	18	7393792216142	
	For Coloric bathtub mixers	GB41637387 01	16	7393792221764	
	Aerator 1,9 liters/min	GB4165040701	10	7391530082851	
	Aerator 3,0 liters/min	GB4165040801	10	7391530084671	
	Aerator 5,0 liters/min	GB4165040901	12	7391530084688	
	Aerator 6,0 liters/min	GB4165042001	12	7391530084695	
		Water saving kit			
		1,9 l/min, PCA, M24, laminar	GB4165042102	25	7391530084701
3,0 l/min, PCA, M24, laminar		GB4165042202	25	7391530084718	
5,0 l/min, PCA, M22, laminar		GB4165042302	27	7391530084725	
	6,0 l/min, PCA, M22, laminar	GB4165042402	27	7391530084732	
	Shut-off for kitchen mixer				
	Chrome	GB41635762 3301	27	7393792207232	
	X-seal for kitchen mixer (2pc in package)	GB41633971 02	10	7393792203951	
	Rubber seals for ceramic cartridge	GB41633513 01	10	7393792203937	
	Soft pex hose M10X1, 2 pcs/package	GB41637161 02	30	7393792217279	

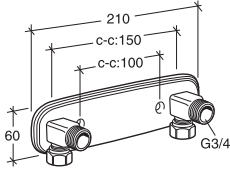
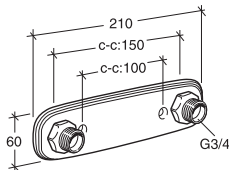
Accessories

		ART No.	Price EUR VAT 0%	EAN
	Wallbracket			
	For copper and Soft pex pipes OD12/15	FG0115080	73	7393792203166
	Wallbracket with concealed piping			
	For copper and steel pipes OD12/15	FG0115050	53	7393792204996
	For Soft pex pipes OD15x2,5	FG0115061	72	7393792212007
	For Soft pex pipes OD16x2,2	FG0115062	64	7393792212014
	Couplings			
	Chrome eccentric (2pcs in package)	GB41631765 02	16	7393792215732
	Matt black rosette for eccentric (2pcs in package)	GB41639921 02	31	7393792235778

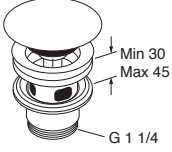
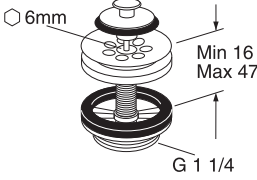
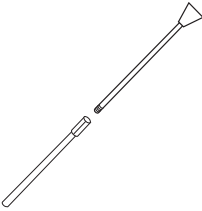
		ART No.	Price EUR VAT 0%	EAN
	Key for outdoor faucet	FG0640560	11	7393792203845
	Ceramic push down valve White Black	GB41636575 25 GB41636575 23	78 94	7393792230797 7393792230810
	Bottom plug for washbasins without overflow	GB41637445	26	7393792221719
	Bottom plug for washbasins without overflow	GB41636574 01	41	7393792231596
	Pop-up waste	GB41637450	37	7393792219211
	Waste bar	GB41630305	11	7393792218702
	Flow meter	GB43000012	76	7393792225137
	Instrument	GB43000014 10	40	7393792226875

WC spare parts 1977 - 2005



325 T
1977 - 1986



325 X
1985 - 1995



NORDIC-BASIC 390
1992 - 2002



NORDIC-BASIC 390
1992 - 2002



SKANDIC 330
1995 - 2005

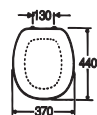

STANDARD SEAT AND COVER
GB192 9900 226

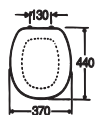

STANDARD SEAT AND COVER
GB192 9900 226

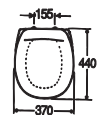

STANDARD SEAT AND COVER
GB191 9901 702

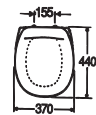

STANDARD SEAT AND COVER
GB191 9901 702

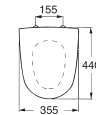

HARD PLASTIC SEAT AND COVER
GB191 99001601

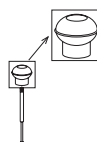

NP-11 PUSHBUTTON
GB192 9900 237

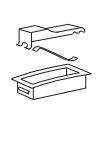

NT-21 PUSHBUTTON
GB192 9900 208



ST-17 CISTERN COVER WITH PUSHBUTTON
GB192 9900 283



ST-24 CISTERN COVER WITH PUSHBUTTON
GB192 9900 338



NP-20 OUTLET VALVE
GB192 9900 238

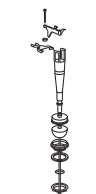

ST OUTLET VALVE
GB192 9900 282

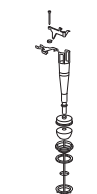

ST OUTLET VALVE
GB192 9900 282

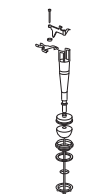

ST OUTLET VALVE
GB192 9900 282

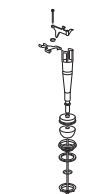

ST OUTLET VALVE
GB192 9900 282

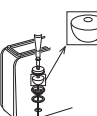

NC VALVEBALL
GB192 9900 260

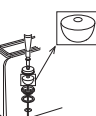

NC VALVEBALL
GB192 9900 260

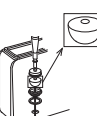

NC VALVEBALL
GB192 9900 260

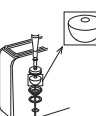

NC VALVEBALL
GB192 9900 260

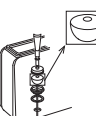

NC VALVEBALL
GB192 9900 260



CISTERN SEALING
GB192 9900 216



CISTERN SEALING
GB192 9900 216



CISTERN SEALING
GB192 9900 320



CISTERN SEALING
GB192 9900 320



CISTERN SEALING
GB192 9900 344



GB-INLET VALVE
9GN00210



GB-INLET VALVE
9GN00210



GB-INLET VALVE
9GN00210



GB-INLET VALVE
9GN00210



GB-INLET VALVE
9GN00210

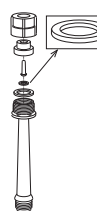

TF-11 RUBBER MEMBRANE
GB192 9900 229



TF-11 RUBBER MEMBRANE
GB192 9900 229



REPLACEMENT OUTLET VALVE, DUO
GB19299M2937

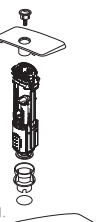

REPLACEMENT OUTLET VALVE, DUO
GB19299M2937

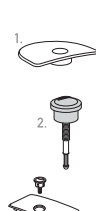

1. CISTERN COVER
GB19299T2800
2. PUSHBUTTON DUO
GB192 99T2 951
PUSHBUTTON SINGLE
GB192 99T2 952



TF-9 FILTER
GB192 9900 228



TF-9 FILTER
GB192 9900 228



1. CISTERN COVER
GB19299U1931
2. PUSHBUTTON DUO
GB192 99T2 951
PUSHBUTTON SINGLE
GB192 99T2 952



1. CISTERN COVER
GB19299U1931
2. PUSHBUTTON DUO
GB192 99T2 951
PUSHBUTTON SINGLE
GB192 99T2 952



REPLACEMENT VALVE DUO
GB19299M2937

WC spare parts 1998 –



CLASSIC 360-364
1998 - 2007

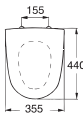

HARD PLASTIC SEAT AND COVER, WHITE
GB191 9901 601
BLACK
GB191 9901 610



CISTERN SEALING
GB192 9900 344



1. CISTERN COVER TWICO
GB192 99T1 929
2. PUSHBUTTON DUO
GB192 99T2 951
PUSHBUTTON SINGLE
GB192 99T2 952

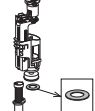

BOTTOM VALVE GASKET TWICO
GB192 99TK 962



OUTLET VALVE DUO BUTTON
GB19299N2953
OUTLET VALVE SINGLE BUTTON
GB19299N2953 + GB19299N2952



OUTLET VALVE WITH PUSHBUTTON
9GN01761
Order with sealing
GB1929900344



GB-INLET VALVE
9GN00210



NORDIC 23XX
2002 -

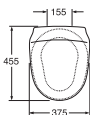

STANDARD SEAT AND COVER
GB191 9902 002

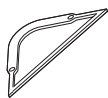

CISTERN SEALING
GB192 9900 320



1. CISTERN COVER
GB192 99K1 931
2. PUSHBUTTON DUO
GB192 99T2 951
PUSHBUTTON SINGLE
GB192 99T2 952

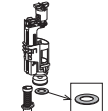

BOTTOM VALVE GASKET TWICO*
GB192 99TK 962



OUTLET VALVE DUO BUTTON*
GB19299N2953
OUTLET VALVE SINGLE BUTTON
GB19299N2953 + GB19299N2952



OUTLET VALVE WITH PUSHBUTTON
9GN01761
Order with sealing
GB192990032



GB-INLET VALVE*
9GN00210

*Also fits for Nordic 339, 393U and 398



ARTIC 43XX
2005 - 2018

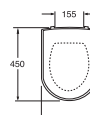

HARD PLASTIC SEAT AND COVER
9M16S101



CISTERN SEALING
GB192 9900 504

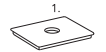

1. CISTERN COVER
GB192 9900 500
2. PUSHBUTTON DUO
GB19299N2951
PUSHBUTTON SINGLE
GB192 99T2 952

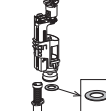

BOTTOM VALVE GASKET TWICO
GB192 99TK 962



OUTLET VALVE DUO BUTTON
GB19299N2953
OUTLET VALVE SINGLE BUTTON
GB19299N2953 + GB19299N2952



OUTLET VALVE WITH PUSHBUTTON
9GN01761
Order with sealing
GB1929900540



GB-INLET VALVE
9GN00210



LOGIC 56XX
2007 - 2013

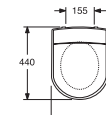

HARD PLASTIC SEAT AND COVER
9M016101

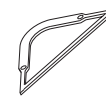

CISTERN SEALING 5696
GB1929900506
CISTERN SEALING 5695
GB192 1100 209



1. CISTERN COVER
8193 B9 01
2. PUSHBUTTON DUO
GB192 99T2 951
PUSHBUTTON SINGLE
GB192 99T2 952

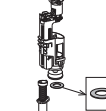
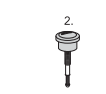

BOTTOM VALVE GASKET TWICO
GB192 99TK 962



OUTLET VALVE DUO BUTTON
GB19299N2953
OUTLET VALVE SINGLE BUTTON
GB19299N2953 + GB19299N2952



OUTLET VALVE WITH PUSHBUTTON
9GN01761
Order with cistern sealing



GB-INLET VALVE
9GN00210



NAUTIC 55XX
2010 - 2017

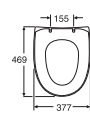

STANDARD COVER
9M246101



ACTUATOR DUAL, WHITE
GB19299P0108
ACTUATOR DUAL, CHROME
GB19299P0110



ACTUATOR SINGLE, WHITE
GB19299P0109
ACTUATOR SINGLE, CHROME
GB19299P0111

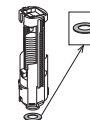

BOTTOM VALVE GASKET TWICO
GB19299TK962



OUTLET VALVE
GB19299P0102



GB-INLET VALVE
GB19299N0105

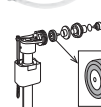

MEMBRANE
GB19299P0106

WC spare parts
2015 -



NAUTIC
2017 -

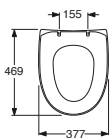

SEAT STANDARD
9M246101

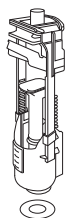

OUTLET VALVE
9GN00100



INLET VALVE
9GN00200



ACTUATOR DUAL,
HIGH VERSION,
CHROME
9GN00561



ACTUATOR SINGLE,
HIGH VERSION,
CHROME
9GN00661



ACTUATOR DUAL,
LOW VERSION,
CHROME
9GN01161



NORDIC³
2017 -

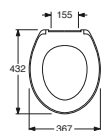

SEAT STANDARD
9M646101

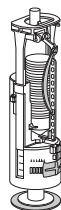

OUTLET VALVE
GB19299S3953



GB-INLET VALVE
9GN00210



PUSHBUTTON
GB19299S3951



ESTETIC
2016 - 2017

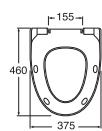

SEAT STANDARD
9M106101

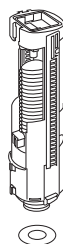

OUTLET VALVE
GB19299P0802



GB-INLET VALVE
GB19299N0105



PUSHBUTTON
GB19299P0801



ESTETIC
2017 -

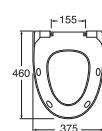

SEAT STANDARD
9M106101

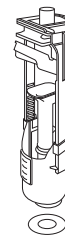

OUTLET VALVE
9GN00100

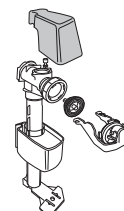

INLET VALVE
9GN00200



PUSHBUTTON
87569961

Technical drawings

Spare parts for Nautic WC, from 2010 - 2017

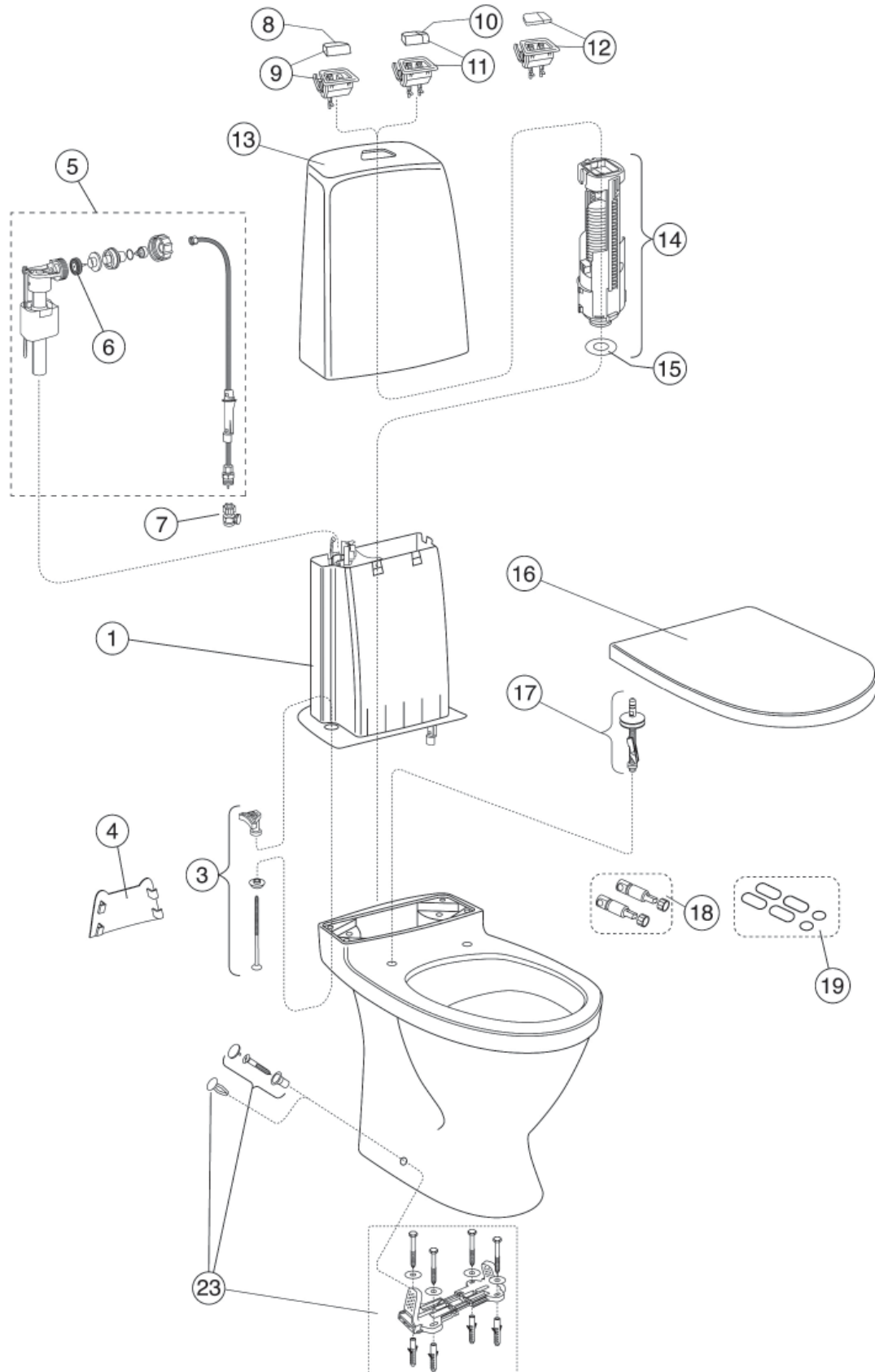

Spare parts for Nautic WC, from 2010 - 2017

		ART No.	Price EUR VAT 0%	EAN
1	Cistern, complete	GB19299N0100	192	7391530070353
2	Tank seal	GB19299P0114	13	4025416099345
3	Cistern fixation set	92226100	11	7391530063744
4	Foot cover	GB1929903410	16	7391530055374
5	Fill valve complete	GB19299N0105	82	4025416099123
6	Membrane	GB19299P0106	10	4025416099109
	Membran for fill valves 9GN00210 and GB19299N0105	9GN00300	38	4051202546175
7	Cisternvalve without filter	GB1929900503	29	7391530059464
8	Push button, single chrome	GB19299P0113	18	4025416099178
	Replacement button vandal-proof	GB19299NNV36	178	7391530071633
9	Actuator single, white	GB19299P0109	30	4025416099284
	Actuator single, chrome	GB19299P0111	37	4025416099291
10	Push button, duo chrome	GB19299P0112	22	4025416099307
11	Actuator dual, white	GB19299P0108	34	4025416099260
	Actuator dual, chrome	GB19299P0110	39	4025416099277
12	Push button low, duo chrome	GB19299P0210	34	7391530066707
13	Cistern Nautic	GB185580001200	136	7391530061900
14	Outlet valve	GB19299P0102	67	4025416099031
15	Seal for outlet valve	GB19299TK962	17	4025416099024
16	Seat and cover standard	9M246101	32	4047289920007
	Seat and cover hard plastic, stainless steel hinges	9M256101	65	4047289984108
	Seat and cover Slimseat, soft-close, quick-release, white	8M45S101	116	4062373839379
	Seat and cover hard plastic, soft-close, quick-release, white	9M26S101	107	4047289984191
	Seat and cover hard plastic, soft-close, quick-release, black	9M26S136	130	4047289984207
17	Hinges soft-close/quick-release for Slimseat 8M245S101	92095761	41	4062373896747
	Stainless steel hinges for 9M256S101 from 2013	92096361	40	4062373899823
18	Fixation details for soft-close seat and cover (2013-)	92241461	41	4051202163198
19	Buffer set for seat and cover	92242001	16	4051202163112
23	Fixation set	92242500	14	4051202166557



Spare parts for Nautic HF WC, from 2017

		ART No.	Price EUR VAT 0%	EAN
1	Cistern, complete	GB19299N0100	192	7391530070353
2	Cistern Nautic	GB185580001200	136	7391530061900
3	Outlet valve	9GN00100	67	4051202546090
4	Fill valve, side inlet	9GN00200	50	4051202546106
5	Inlet tube flex. hose w.connector	9GN01000	81	4051202546151
6	Membrane	9GN00300	38	4051202546175
7	Actuator dual, high version, chrome	9GN00561	59	4051202546229
8	Actuator single, high version, chrome	9GN00661	54	4051202546137
	Replacement button vandal-proof	GB19299NNV36	178	7391530071633
9	Actuator dual, flat version	9GN01161	59	4051202546182
10	Wood screw bag	GB1929900365	25	4022693590664
11	Valve house gasket	9GN00400	32	4051202546168
12	Fixation set	92242500	14	4051202166557
13	Cistern fixation set	92226100	11	7391530063744
14	Seat and cover standard	9M246101	32	4047289920007
	Seat and cover hard plastic, stainless steel hinges	9M256101	65	4047289984108
	Seat and cover Slimseat, soft-close, quick-release, white	8M45S101	116	4062373839379
	Seat and cover hard plastic, soft-close, quick-release, white	9M26S101	107	4047289984191
	Seat and cover hard plastic, soft-close, quick-release, black	9M26S136	130	4047289984207
15	Hinges soft-close/quick-release for Slimseat 8M45S101	92095761	41	4062373896747
	Stainless steel hinges for 9M256S101 from 2013	92096361	40	4062373899823
16	Cisternvalve without filter	GB1929900503	29	7391530059464
17	Foot cover	GB1929903410	16	7391530055374
21	Dumper set for soft-close seat and cover (2013-)	92242400	64	4051202163105
22	Buffer set for seat and cover	92242001	16	4051202163112

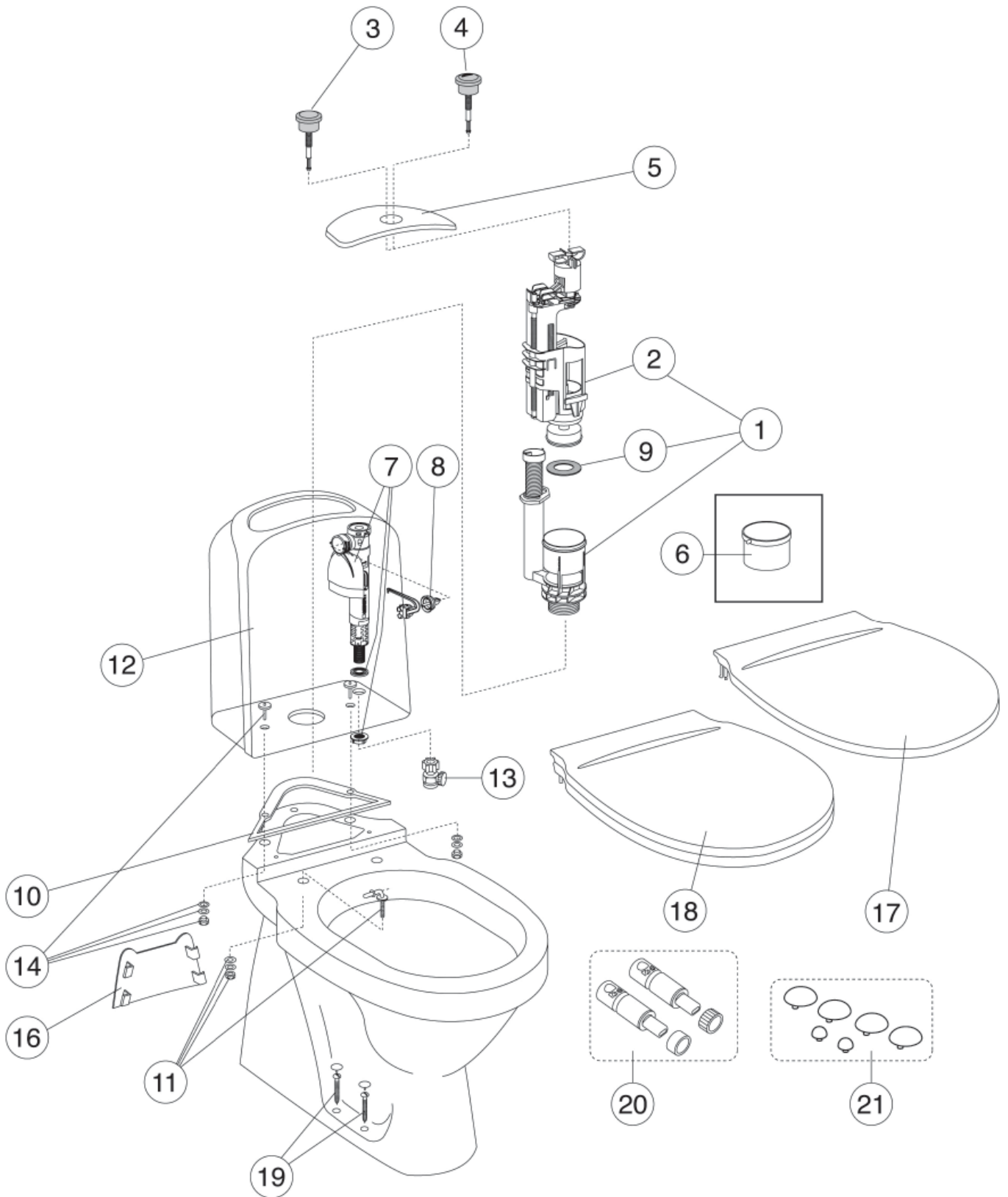

Spare parts for Nordic WC, from 2002 -

		ART No.	Price EUR VAT 0%	EAN
1	Complete outlet valve with pushbutton (must be ordered with sealing GB1929900320)	9GN01761	57	4062373890448
2	Outlet valve with pushbutton Duo, Twico 2	GB19299N2953	47	4025416281726
3	Pushbutton Single chrome, Twico 2	GB19299T2952	25	7391530057347
	Pushbutton Single chrome	GB19299K1951	30	7391530054407
4	Pushbutton Duo chrome, Twico 2	GB19299T2951	25	7391530057330
	Pushbutton Duo chrome, Twico 1	GB19299T1951	44	7391530054339
	Pushbutton Duo chrome for outlet valve GB19299N2953	GB19299N2951	27	4025416311034
5	Cisterncover Twico1/Twico 2, white	GB19299K1931	19	7391530054490
6	Adapter, Kega to Twico 2	GB19299KT959	32	7391530057491
7	GB-inlet valve	9GN00210	51	4062373894026
8	Membrane for inlet valve GB1929901972	GB19299P0206	11	4025416500261
	Memebrane for inlet valve 9GN00210	9GN00300	38	4025416500261
9	Outlet valve gasket	GB19299TK962	17	7391530054360
	Outlet valve gasket	9GN00400	32	4051202546168
10	Cisternsealing	GB1929900320	16	7391530029979
11	Stainless steel hinges for seat and cover GB1919902070	GB1919901840	36	7391530070421
	Fixation set for soft-close seat and cover	GB1919901845	36	7391530070445
12	Cistern with inner tank Nordic	GB184700S11200	216	4062373847176
13	Cisternvalve without filter	GB1929900503	29	7391530059464
14	Cistern bolts (2 pcs)	GB1929900319	30	7391530059457
16	Foot cover	GB1929903410	16	7391530055374
17	Seat and cover standard	GB1919902002	30	7391530051833
18	Seat and cover soft-close, white	8M56S101	108	4062373888643
	Cover for dumper (2 pcs) for seat and covers GB1919902055, GB1919902065, 9MI1S101, 9MI1S136	GB1919901841	10	7391530073644
19	Wood screw bag	GB1929900365	25	4022693590664
20	Dumper set for seat and cover 8M56S101	92096600	63	4062373902936
21	Buffer set for seat and cover 8M56S101	92096700	16	4062373902929

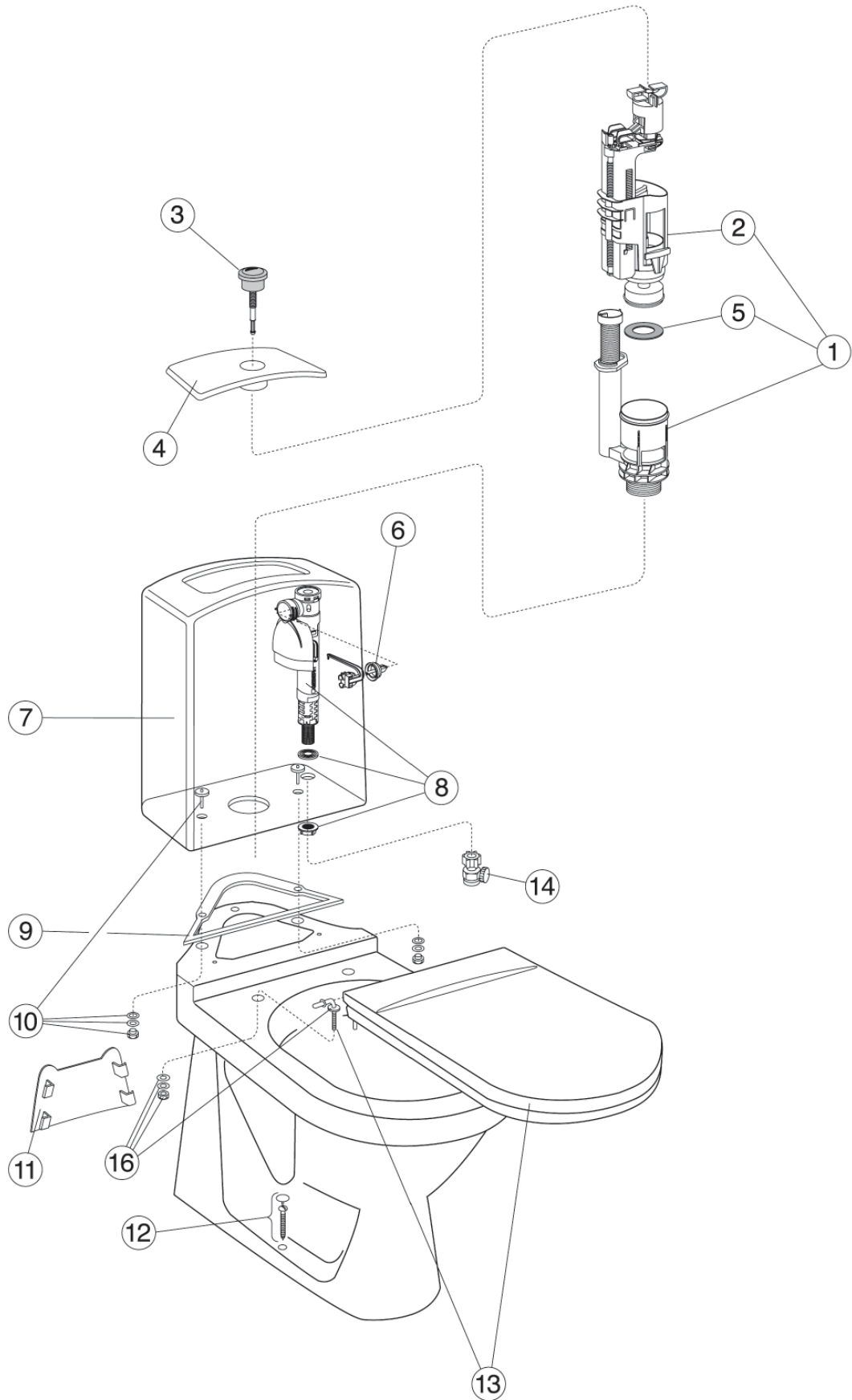

Spare parts for Logic WC, 2007- 2013

		ART No.	Price EUR VAT 0%	EAN
1	Complete outlet valve with pushbutton (must be ordered with sealing GB1929900320)	9GN01761	57	4062373890448
2	Outlet valve with pushbutton Duo, Twico 2	GB19299N2953	47	4025416281726
3	Pushbutton Duo chrome, Twico 2	GB19299T2951	25	7391530057330
	Pushbutton Duo chrome for outlet valve GB19299N2953	GB19299N2951	27	4025416311034
4	Cisterncover Twico 2	8193B901	19	4047289794004
5	Outlet valve gasket	GB19299TK962	17	7391530054360
	Outlet valve gasket	9GN00400	32	4051202546168
6	Membrane for inlet valve 9GS01300	9GS01400	9	4051202546212
	Membrane for inlet valve GB1929901972	GB19299P0206	11	4025416500261
	Memebrane for inlet valve 9GN00210	9GN00300	38	4025416500261
7	Cistern with inner tank Nordic	GB184700S11200	216	4062373847176
8	GB-inlet valve	9GN00210	51	4062373894026
9	Cisternsealing for WC 5695	GB1929900506	22	7391530070384
	Cisternsealing	GB1929900320	16	7391530029979
10	Cistern bolts (2 pcs)	GB1929900319	30	7391530059457
11	Foot cover	GB1929903410	16	7391530055374
12	Wood screw bag	GB1929900365	25	4022693590664
	Plugs for floor WC fastening holes, white	GB1929900168	16	7391530070452
13	Seat and cover soft-close, white	9M11S101	201	5708590283258
	Cover for dumper (2 pcs) for seat and covers GB1919902055, GB1919902065, 9M11S101, 9M11S136	GB1919901841	10	7391530073644
14	Cisternvalve without filter	GB1929900503	29	7391530059464
16	Stainless steel hinges for seat and cover 9M016101	9M010161	36	4022693989956
	Fixation details for soft-close seat and covers 9M11S101 and 9M11S136	GB1919901845	36	4022693989956

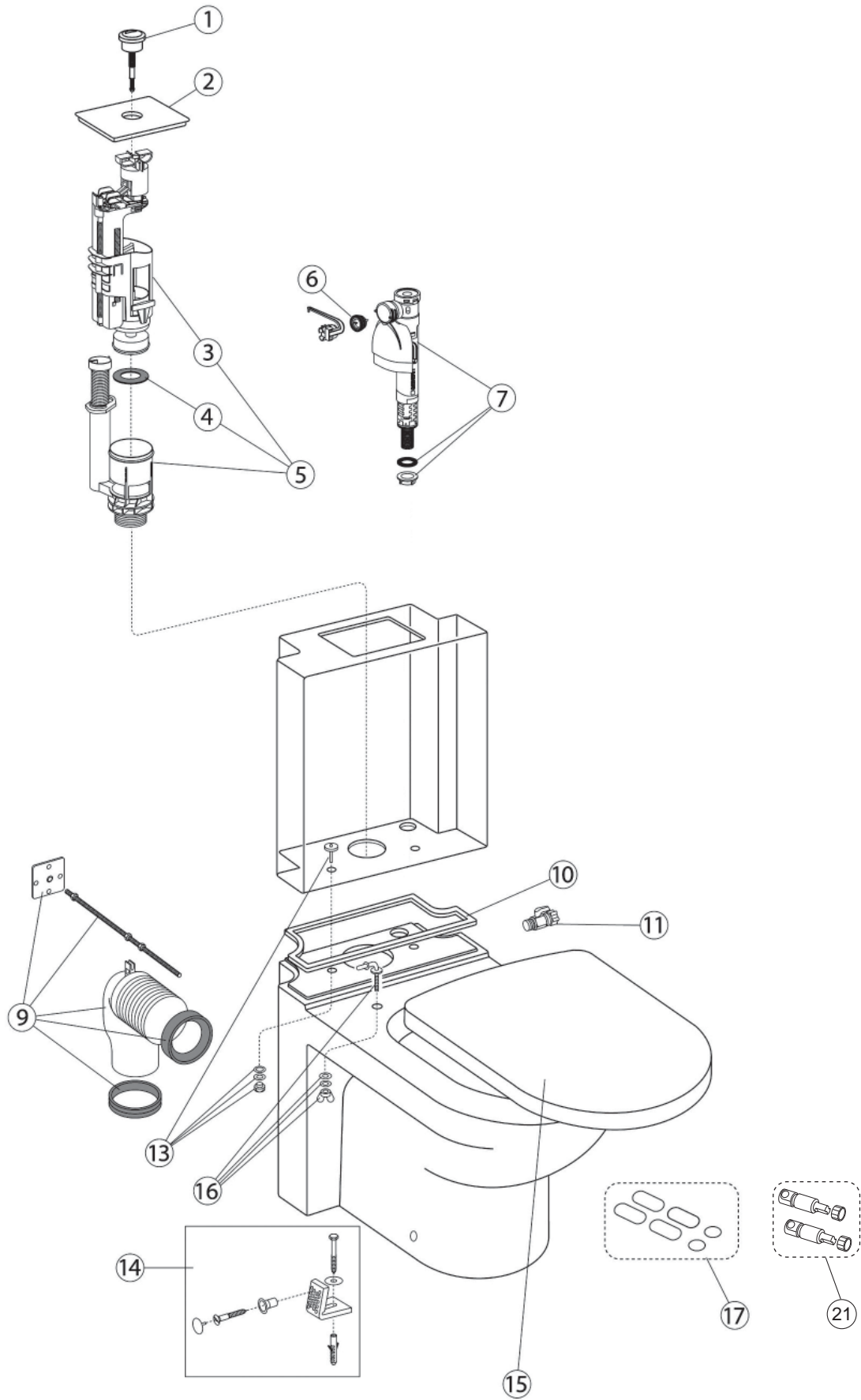

Spare parts for Artic WC, from 2005 - 2018

		ART No.	Price EUR VAT 0%	EAN
1	Pushbutton Duo chrome, Twico 2	GB19299T2951	25	7391530057330
	Pushbutton Duo chrome for outlet valve GB19299N2953	GB19299N2951	27	4025416311034
2	Cistern cover	GB1929900500	25	7391530059440
3	Outlet valve with pushbutton Duo	GB19299N2953	47	4025416281726
4	Outlet valve gasket for 9GS01600	9GS01700	9	4051202546250
	Outlet valve gasket	GB19299TK962	17	7391530054360
	Outlet valve gasket	9GN00400	32	4051202546168
5	Complete outlet valve with pushbutton (must be ordered with sealing GB1929900504)	9GN01761	57	4062373890448
6	Membrane for inlet valve GB1929901972	GB19299P0206	11	4025416500261
7	GB-inlet valve	9GN00210	51	4062373894026
9	Outlet connection	87110000	70	4015211194062
10	Cistern sealing	GB1929900504	16	7391530059471
11	Cisternvalve without filter	GB1929900503	29	7391530059464
13	Cistern bolts	GB1929900505	31	7391530059488
14	Floorfastening set	GB1929900381	30	7391530056227
15	Seat and cover soft-close, white	9M16S101	156	4047289718109
	Seat and cover soft-close, black	9M16S136	238	4047289718116
16	Fixation details for soft-close seat and covers 9M16S101 and 9M16S136 (2013-)	92241761	41	4051202163341
17	Buffer set for seat and cover	92242201	18	4051202163167
21	Dumper set for soft-close seat and cover (2013-)	92242400	64	4051202163105

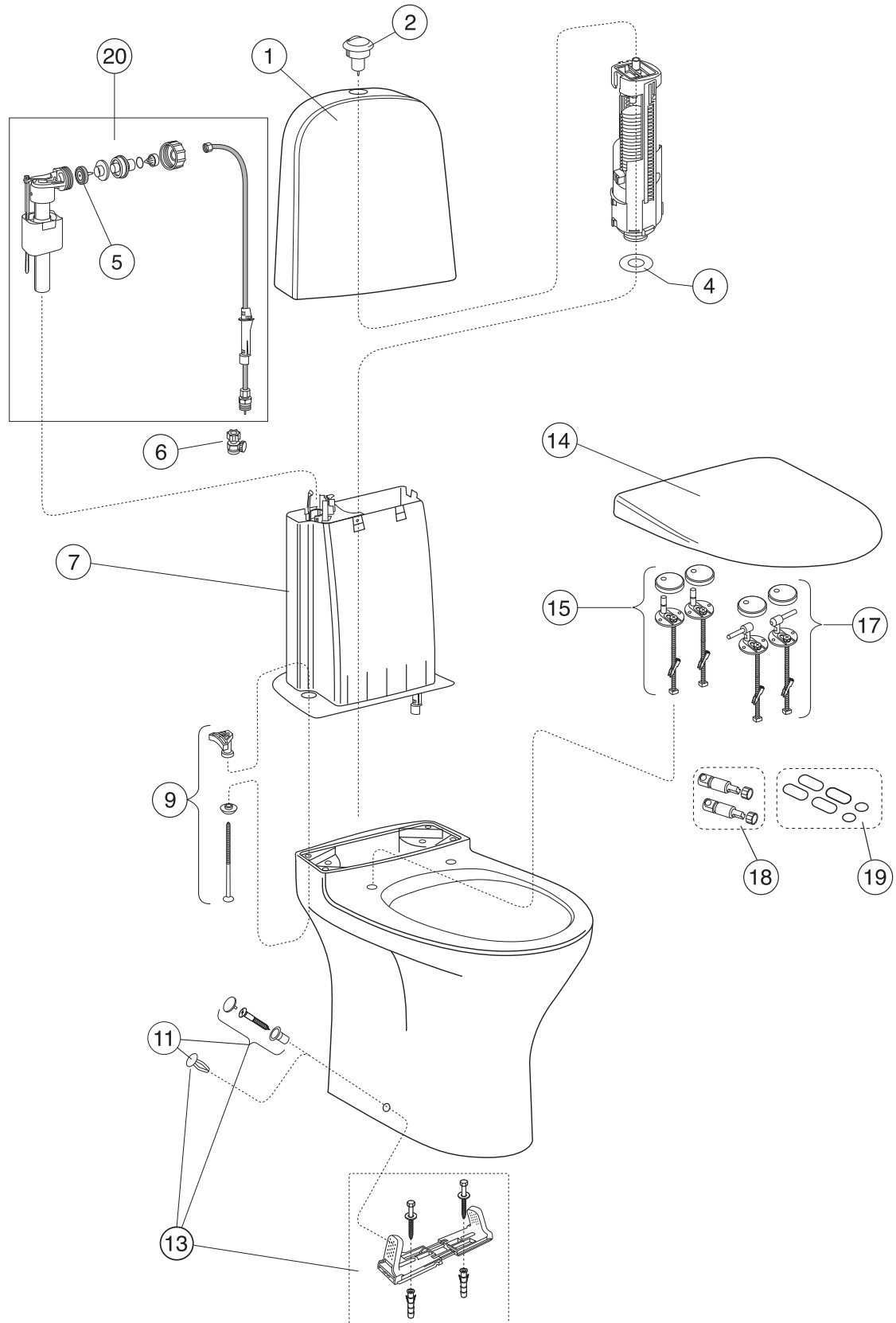

Spare parts for Estetic WC, from 2016 - 09.2017

		ART No.	Price EUR VAT 0%	EAN
1	Cistern, White	GB18830001200	184	7391530070827
	Cistern, Matt white	GB18830041200	231	7391530070810
	Cistern, Black	GB18830036200	231	7391530070803
2	Push button Duo, mattchrome	GB19299P0801	19	7391530070834
4	Valve house gasket	GB19299TK962	17	4025416099024
5	Membrane	GB19299P0106	10	4025416099109
6	Cisternvalve without filter	GB1929900503	29	7391530059464
7	Complete inner tank	GB19299N0101	168	4062373880128
8	Tank seal	GB19299P0114	13	4025416099345
9	Cistern fixation set	92226100	11	7391530063744
11	Wood screw bag	GB1929900365	25	4022693590664
13	Fiaxation set	92214501	16	4051202485955
14	Seat and cover hard plastic, soft-close, quick-release, white	9M10S101	156	4051202251611
	Seat and cover hard plastic, soft-close, quick-release, matt white	9M10S1RW	196	4051202843588
	Seat and cover hard plastic, soft-close, quick-release, black	9M10S136	196	4051202336219
	Seat and cover hard plastic, soft-close, quick-release, ebony matt black	9M10S133	232	4065467166634
15	Soft-close, quick-release hinges	92213161	39	4051202478094
17	Stainless steel hinges	92213261	39	4051202478100
18	Dumper set for soft-close seat and cover	92213300	65	4051202478117
19	Buffer set for seat and cover	92213400	17	4051202205423
20	Inlet valve	GB19299N0105	82	4062373882375

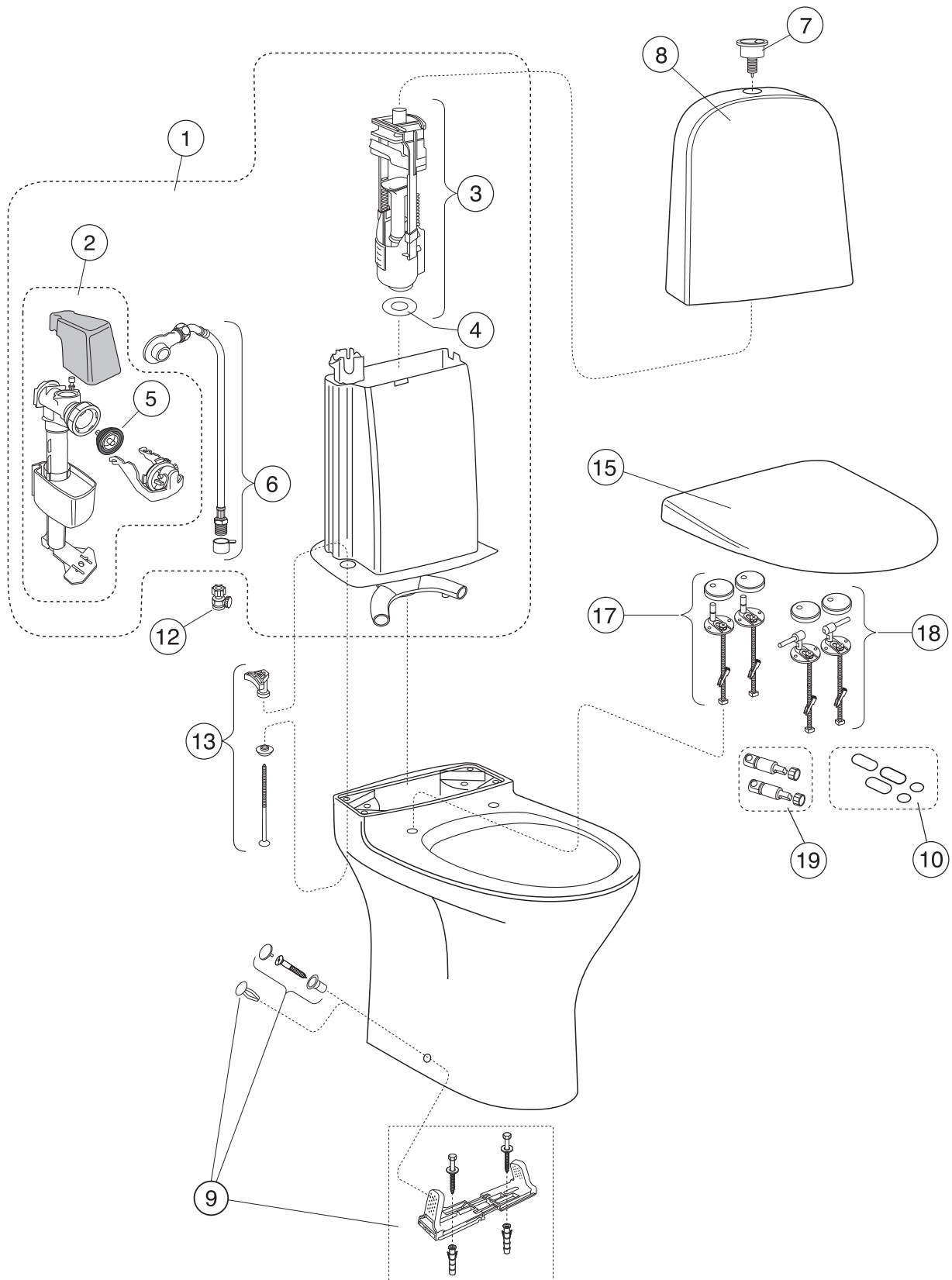

Spare parts for Estetic WC, from 09.2017

		ART No.	Price EUR VAT 0%	EAN
1	Complete inner tank	GB19299N0101	168	4062373880128
2	Fill valve, side inlet	9GN00200	50	4051202546106
3	Outlet valve	9GN00100	67	4051202546090
4	Valve house gasket	9GN00400	32	4051202546168
5	Membrane	9GN00300	38	4051202546175
6	Inlet tube flex. hose w.connector	9GN01000	81	4051202546151
7	Push button Duo	87569861	25	4051202844325
	Push button Duo Black	875698K5	27	7391530081045
	Push button single flush, Public	9GN016D7	105	4062373887202
8	Cistern, White	GB18830001200	184	7391530070827
	Cistern, Matt white	GB18830041200	231	7391530070810
	Cistern, Black	GB18830036200	231	7391530070803
	Cistern, Ebony matt black	GB18830033200	231	7391530075624
	Cistern, matt black	GB18830038200	231	4065467445265
9	Fixation set	92214501	16	4051202485955
10	Buffer set for seat and cover	92213400	17	4051202205423
12	Cisternvalve without filter	GB1929900503	29	7391530059464
13	Cistern fixation set	92226100	11	7391530063744
15	Seat and cover hard plastic, soft-close, quick-release, white	9M10S101	156	4051202251611
	Seat and cover hard plastic, soft-close, quick-release, matt white	9M10S1RW	196	4051202843588
	Seat and cover hard plastic, soft-close, quick-release, black	9M10S136	196	4051202336219
	Seat and cover hard plastic, soft-close, quick-release, ebony matt black	9M10S133	232	4065467166634
	Seat and cover hard plastic, soft-close, quick-release, matt black	9M10S138	232	4065467445272
17	Soft-close, quick-release hinges	92213161	39	4051202478094
18	Stainless steel hinges	92213261	39	4051202478100
19	Dumper set for soft-close seat and cover	92213300	65	4051202478117

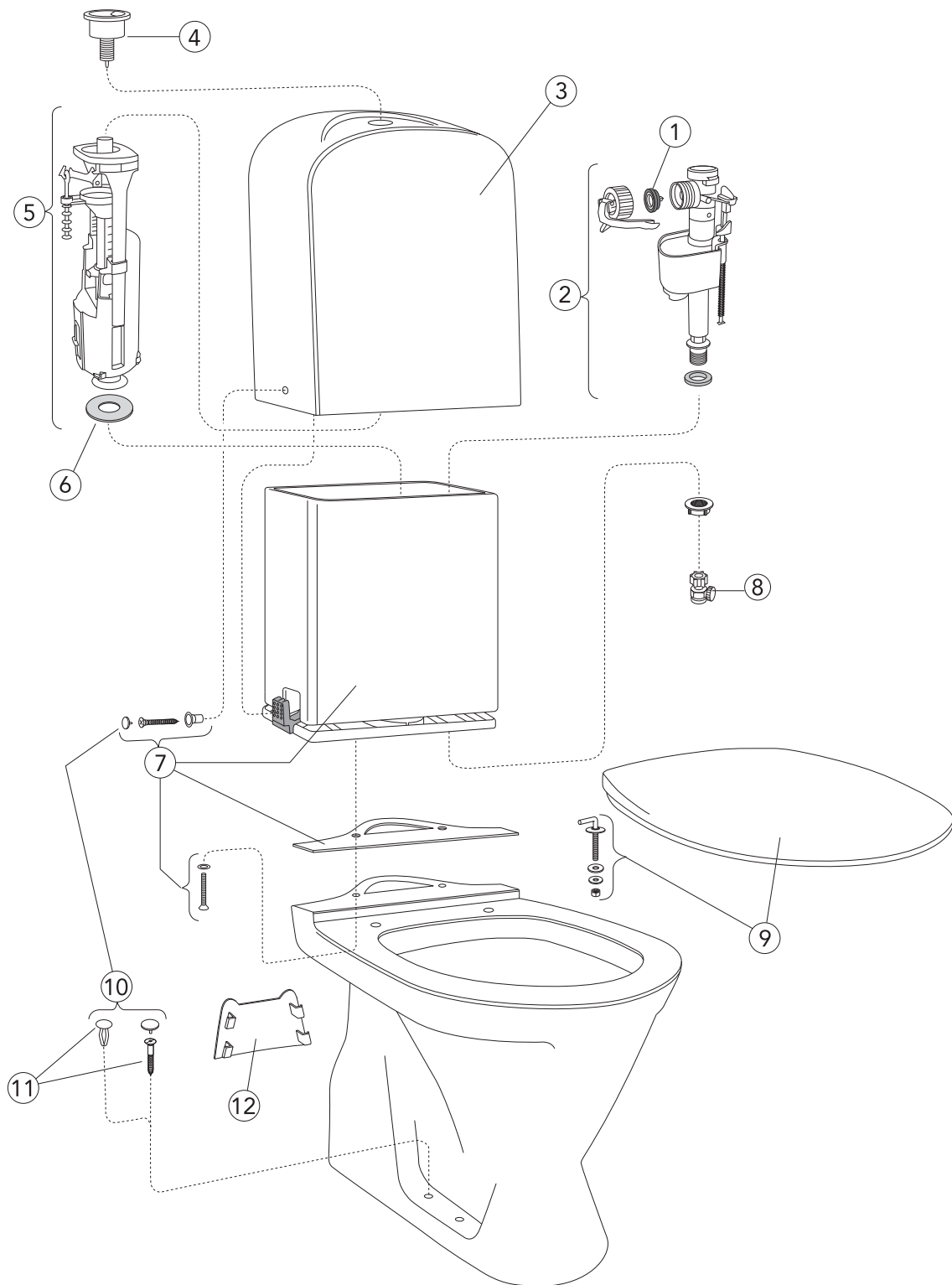

Spare parts for Nordic³ WC, from 2015-2017

		ART No.	Price EUR VAT 0%	EAN
1	Membrane for inlet valve GB1929901972	GB19299P0206	11	4025416500261
	Memebran for inlet valve 9GS01300	9GS01400	9	4051202546212
	Memebran for inlet valve 9GN00210	9GN00300	38	4051202546175
2	GB-inlet valve	9GN00210	51	4062373894026
3	Cistern, white	GB184700001200	141	7391530070414
4	Pushbutton Duo, chrome for outlet valve GB19299P0202	GB19299P0201	25	4025416507147
5	Complete outlet valve with pushbutton for models 2015-2017 only	GB19299P0202	68	4025416507314
	Complete outlet valve with pushbutton, universal	9GN01761	57	4062373890448
6	Bottomvalve gasket	GB19299TK962	17	4025416099024
7	Cistern fastening set	GB19299P0204	30	7391530066998
8	Cisternvalve without filter	GB1929900503	29	7391530059464
9	Seat and cover standard, white	9M646101	30	4051202257101
	Seat and cover hard plastic, stainless steel hinges	8780G101	52	4022693743008
	Seat and cover soft-close, white	8780S101	71	4051202349509
	Stainless steel hinges for seat and cover 8780G101	92241961	25	4051202163310
	Stainless steel hinges for seat and cover 8780S101	92211761	39	4051202474461
	Dumper set for soft-close seat and cover	92242400	64	4051202163105
	Buffer set for seat and cover	92242101	23	4051202163136
10	Screw caps	GB19299P0207	36	7391530067308
11	Fastening screw set, 4 pcs	GB1929900365	25	4022693590664
12	Foot cover	GB1929903410	16	7391530055374

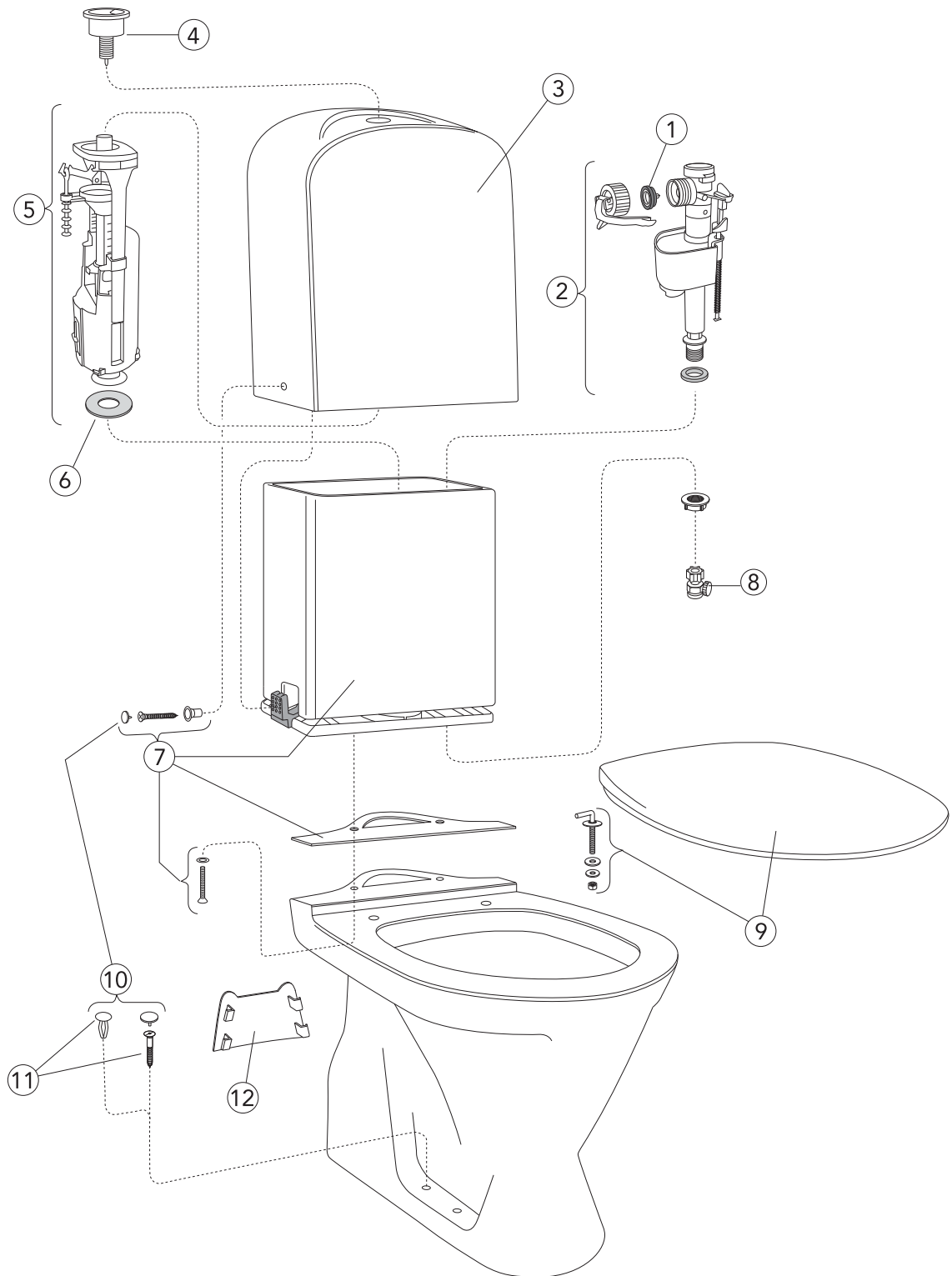

Spare parts for Estetic WC, from 2017

		ART No.	Price EUR VAT 0%	EAN
1	Membrane	9GS01400	9	4051202546212
	Memebran for inlet valve 9GN00210	9GN00300	38	4051202546175
2	GB-inlet valve	9GN00210	51	4062373894026
3	Cistern, white	GB184700001200	141	7391530070414
4	Complete outlet valve with pushbutton	GB19299S3953	51	7391530081526
	Pushbutton, Duo for GB19299S3953	GB19299S3951	14	7391530066196
6	Bottomvalve gasket	9GS01700	9	4051202546250
7	Cistern, complete	GB19299S0100	146	7391530074542
	Cistern fastening set	GB19299P0204	30	7391530066998
8	Cisternvalve without filter	GB1929900503	29	7391530059464
9	Seat and cover standard, white	9M646101	30	4051202257101
	Seat and cover hard plastic, stainless steal hinges	8780G101	52	4022693743008
	Seat and cover soft-close, white	8780S101	71	4051202349509
	Stainless steel hinges for seat and cover 8780G101	92241961	25	4051202163310
	Stainless steel hinges for seat and cover 8780S101	92211761	39	4051202474461
	Dumper set for soft-close seat and cover	92242400	64	4051202163105
	Buffer set for seat and cover	92242101	23	4051202163136
10	Screw caps	GB19299P0207	36	7391530067308
11	Fastening screw set, 4 pcs	GB1929900365	25	4022693590664
12	Foot cover	GB1929903410	16	7391530055374

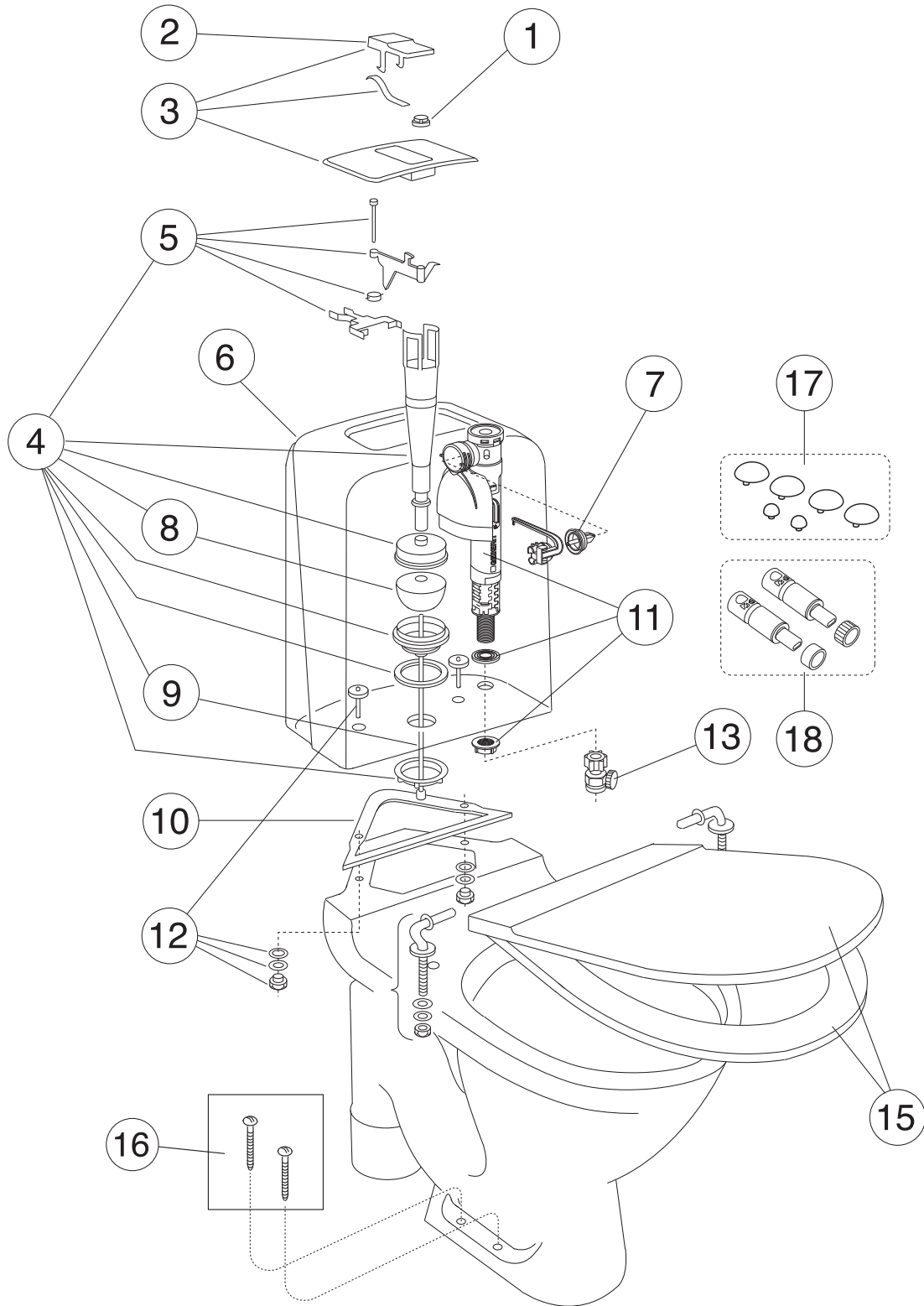

Spare parts for Basic WC, 1992 - 2002

		ART No.	Price EUR VAT 0%	EAN
1	Capnut	GB1929901545	11	7391530064956
2	Pushbutton, white	GB1929900278	25	7391530029955
3	Cistern cover, with pushbutton	GB1929900283	31	7391530029894
	Basic Duo pushbutton+cover, white	GB1929900361	30	7391530038629
	NT-29 pushbutton+frame, white	GB1929900324	34	7391530032214
4	Outlet valve	GB1929900282	36	7391530029368
	Replacement valve Duo	GB19299M2937	73	4062373894927
	Outlet valve with pushbutton Duo	GB19299N2953	47	4025416281726
5	ST-22 lifting arrangement	GB1929900209	19	7391530030722
6	Cistern, without accessories, white	GB1042900101	168	7391530029412
7	Membrane for inlet valve 9GS1300	9GS01400	9	4051202546212
	Membrane for inlet valve GB1929901972	GB19299P0206	11	4025416500261
	Membrane for inlet valve 9GN00210	9GN00300	38	4025416500261
8	Valveball	GB1929900260	16	7391530029993
9	ST-2 centre rod	GB1929900347	11	7391530034812
10	Cistern sealing	GB1929900320	16	7391530029979
11	GB-inlet valve	9GN00210	51	4062373894026
12	Cistern bolts (2 pcs)	GB1929900319	30	7391530031255
13	Cisternvalve without filter	GB1929900503	29	7391530059464
15	Seat and cover standard, white	GB1919901702	27	7391530029986
	Seat and cover soft-close, quick-release, white	8M56S101	108	4062373888643
16	Wood screw bag	GB1929900365	25	4022693590664
17	Buffer set for seat and cover 8M56S101	92096700	16	4062373902929
18	Dumper set for seat and cover 8M56S101	92096600	63	4062373902936
	Cistern with inner tank Nordic	GB184700S11200	216	4062373847176

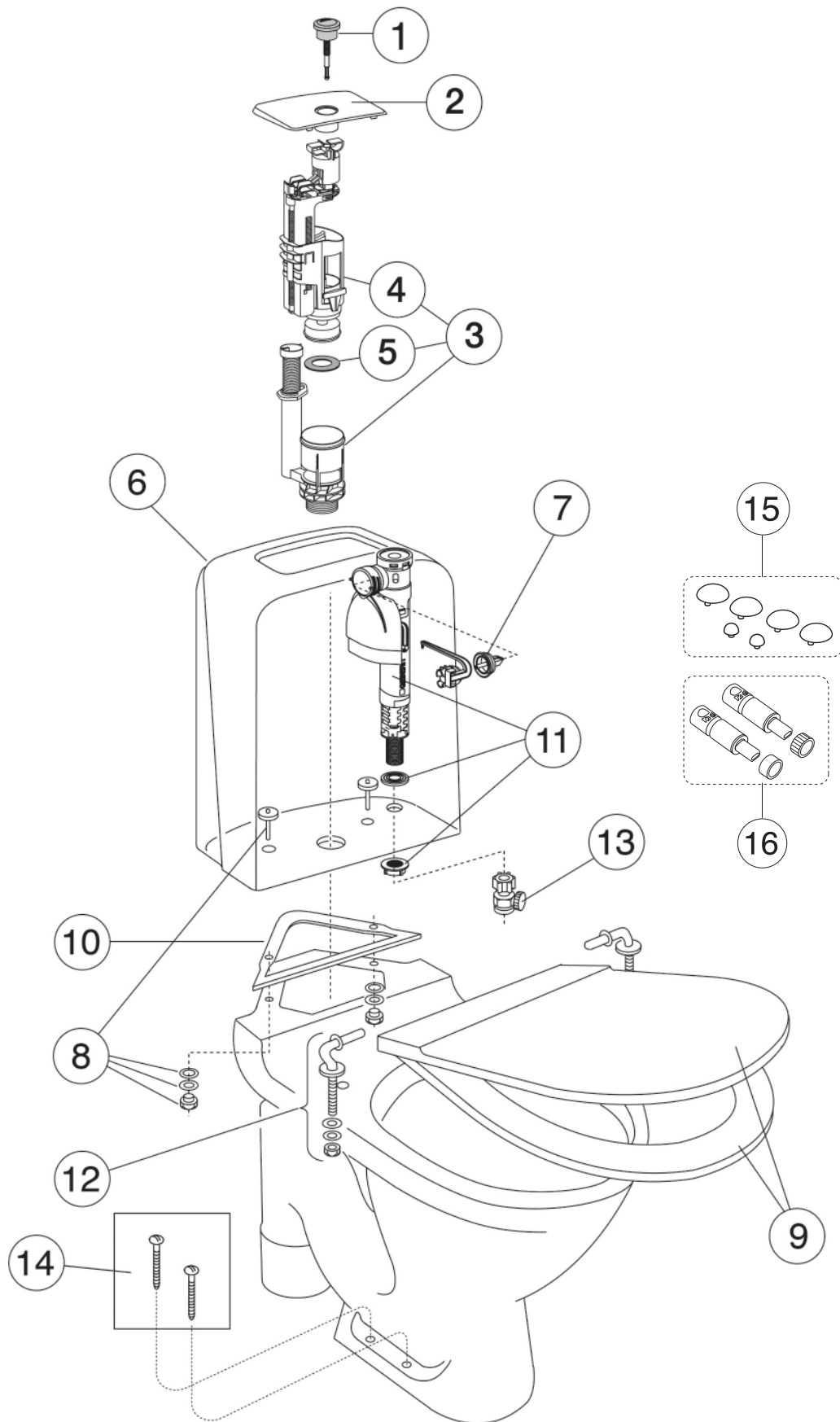

Spare parts for Basic WC, 2003 - 2017

		ART No.	Price EUR VAT 0%	EAN
1	Pushbutton Duo chrome, Twico 2	GB19299T2951	25	7391530057330
	Pushbutton Duo chrome, Twico 1	GB19299T1951	44	7391530054339
	Pushbutton Duo chrome for outlet valve GB19299N2953	GB19299N2951	27	4025416311034
2	Cistern cover TI/TII/K, white	GB19299U1931	19	7391530054445
3	Complete outlet valve with pushbutton (must be ordered with sealing (GB1929900320)	9GN01761	57	4062373890448
4	Outlet valve with pushbutton Duo	GB19299N2953	47	4025416281726
5	Outlet valve gasket for 9GS01600	9GS01700	9	4051202546250
	Outlet valve gasket	GB19299TK962	17	7391530054360
6	Cistern, without accessories, white	GB1042900101	168	7391530029412
7	Membrane for inlet valve 9GS1300	9GS01400	9	4051202546212
	Membrane for inlet valve GB1929901972	GB19299P0206	11	4025416500261
	Membrane for inlet valve 9GN00210	9GN00300	38	4025416500261
8	Cistern bolts (2 pcs)	GB1929900319	30	7391530031255
9	Seat and cover standard, white	GB1919901702	27	7391530029986
	Seat and cover soft-close, quick-release, white	8M56S101	108	4062373888643
10	Cistern sealing	GB1929900320	16	7391530029979
11	GB-inlet valve	9GN00210	51	4062373894026
13	Cisternvalve without filter	GB1929900503	29	7391530059464
14	Wood screw bag	GB1929900365	25	4022693590664
15	Buffer set for seat and cover 8M56S101	92096700	16	4062373902929
16	Dumper set for seat and cover 8M56S101	92096600	63	4062373902936

		ART No.	Price EUR VAT 0%	EAN
1	NP-11 Lifting knob	GB1929900237	36	7391530030531
2	NP-20 Outlet valve	GB1929900238	47	7391530030517
3	Valveball	GB1929900245	9	7391530029917
4	NP-10 Lock nut	GB1929900236	11	7391530032269
5	Cistern without cover and fastening set	GB1042060101	160	7391530021195
6	Cistern gasket	GB1929900316	31	7391530031217
7	Hinges for seat and cover	GB1929901453	11	7391530030081
8	Cistern bolts (2 pcs)	GB1929900217	30	7391530031248
9	Wood screw bag	GB1929900365	25	4022693590664
10	Standard seat and cover	GB1919900910	109	7391530030043
	Standard seat w/o cover	GB1919901286	25	7391530030036
11	GB-inlet valve with side connection, retail package	GB1929901974	71	7391530059396
12	Membrane	GB19299P0206	11	4025416500261

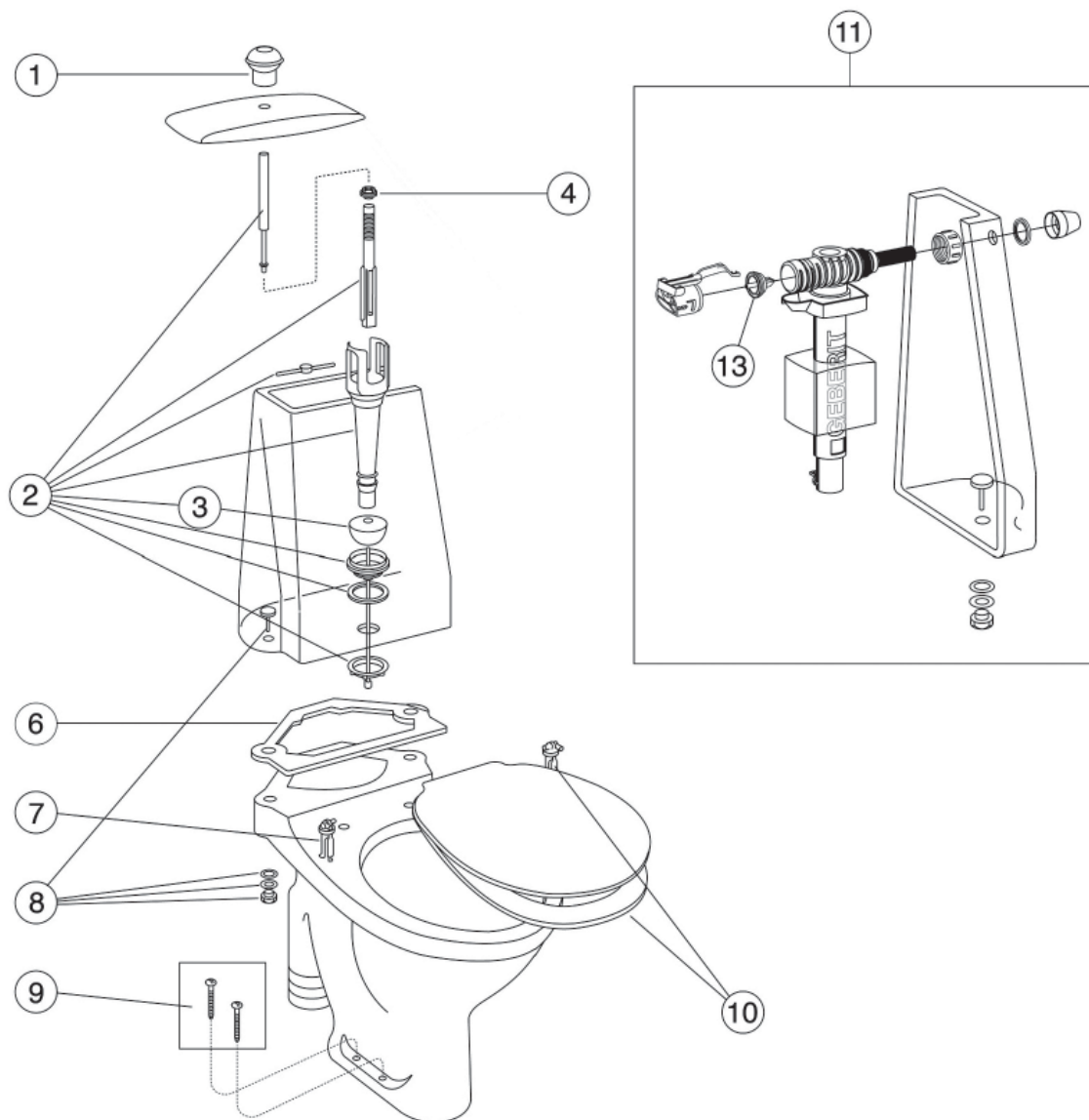

Spare parts for Nautic WC 5530 from 2010 -

	ART No.	Price EUR VAT 0%	EAN
1 Wall fixation set	92207401	21	4047289348085
2 Seat and cover standard	9M246101	32	4047289920007
3 Seat and cover hard plastic, stainless steel hinges	9M256101	65	4047289984108
4 Seat and cover Slimseat, soft-close, quick-release, white	8M45S101	116	4062373839379
5 Seat and cover hard plastic, soft-close, quick-release, white	9M26S101	107	4047289984191
6 Seat and cover hard plastic, soft-close, quick-release, black	9M26S136	130	4047289984207
7 Hinges soft-close/quick-release	92095761	41	4062373896747
8 Stainless steel hinges for 9M256S101 from 2013	92096361	40	4062373899823
9 Buffer set for seat and cover	92242001	16	4051202163112
10 Dumper set for soft-close seat and cover (2013-)	92242400	64	4051202163105

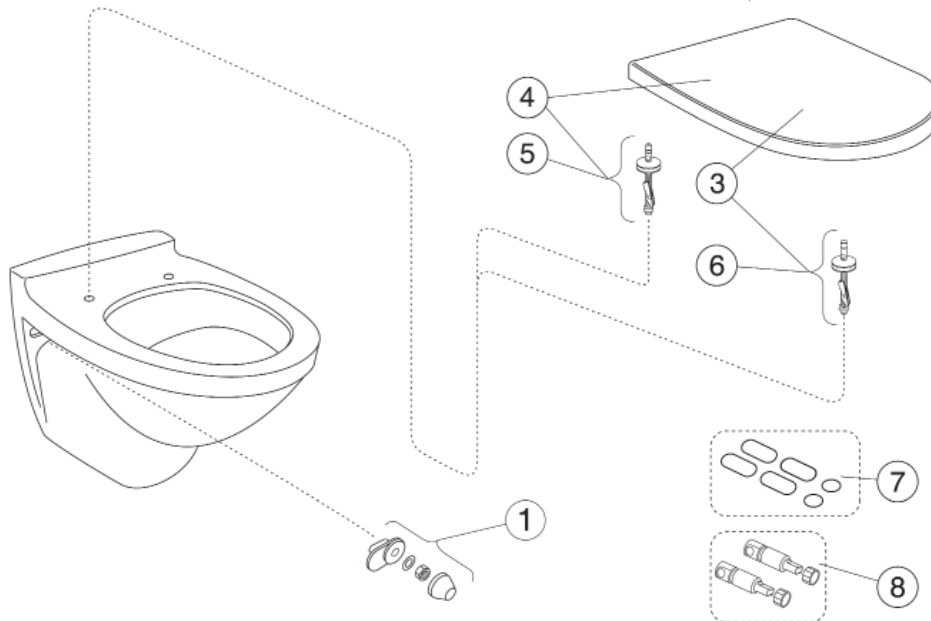

Spare parts for Hygienic Flush WC 5G84, from 2014 -

	ART No.	Price EUR VAT 0%	EAN
1 Wallfixing set, white for WC 5G84	92185901	21	4022693716965
2 Seat and cover soft-close, white	9M16S101	156	4047289718109
3 Seat and coversoft-close, black	9M16S136	238	4047289718116
4 Stainless steel hinges for seat and covers 98895101	92237061	39	4051202544515
5 Fixation details for soft-close seat and covers 9M16S101 and 9M16S136 (2013-)	92241761	41	4051202163341
6 Buffer set for hard seat and cover	92236800	18	4051202544508
7 Buffer set for seat and cover 9M16S101 and	92242201	18	4051202163167
8 Dumper set for soft-close seat and cover (2013-)	92242400	64	4051202163105

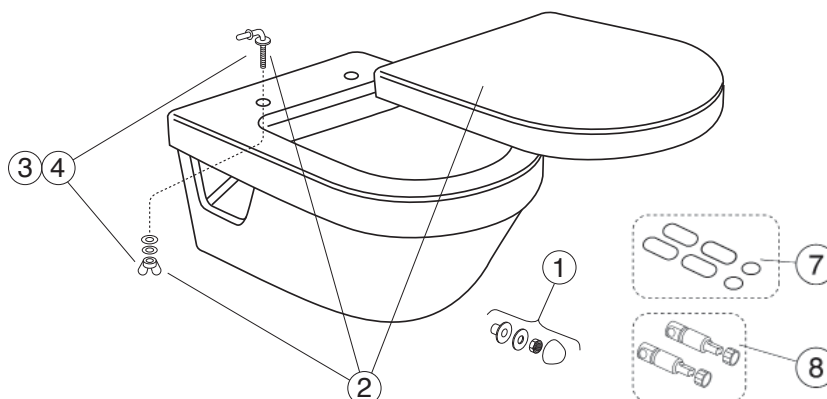

Spare parts for Logic WC 5693, from 2007 - 2017

- 1 Wallfixing set, white for WC 5693
- 2 Seat and cover soft-close, white
- 3 Fixation details for soft-close seat and cover
- 4 Stainless steel hinges

ART No.	Price EUR VAT 0%	EAN
92207401	21	4047289348085
9M11S101	201	5708590283258
GB1919901845	36	4022693989956
9M010161	36	4022693989956

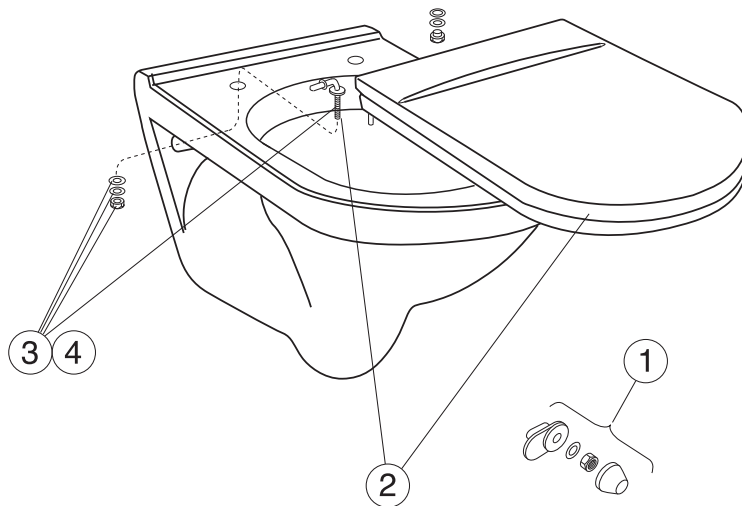

Spare parts for Artic WC 4330, from 2005 -

- 1 Wallfixing set, white for WC 4330
- 2 Seat and cover soft-close, white
Seat and coversoft-close, black
- 4 Fixation details for soft-close seat and cover
- 7 Buffer set for seat and cover 9M16S101
- 8 Dumper set for soft-close seat and cover (2013-)

ART No.	Price EUR VAT 0%	EAN
92207401	21	4047289348085
9M16S101	156	4047289718109
9M16S136	238	4047289718116
92241761	41	4051202163341
92242201	18	4051202163167
92242400	64	4051202163105

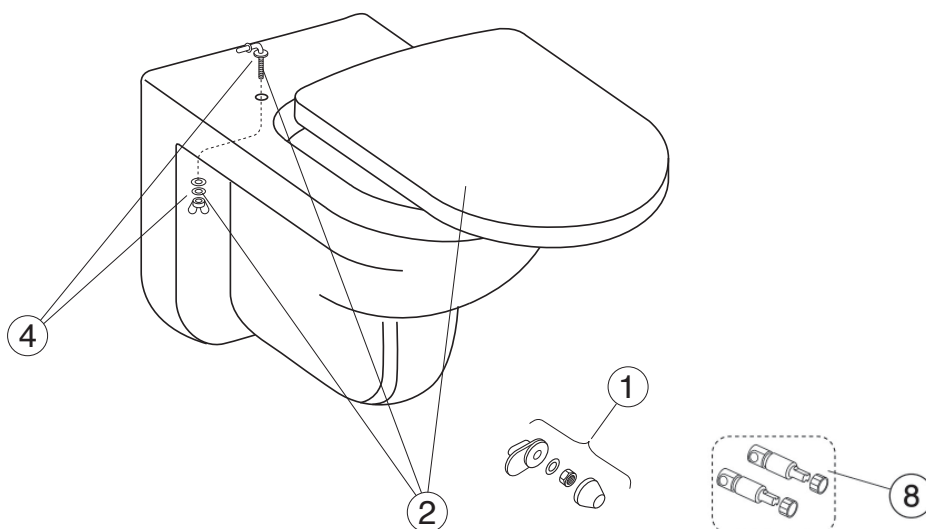

Spare parts for Estetic WC 8330, from 2016 -

		ART No.	Price EUR VAT 0%	EAN
1	Seat and cover hard plastic, soft-close, quick-release, matt white	9M09S1RW	196	4051202843526
	Seat and cover hard plastic, soft-close, quick-release, black	9M09S136	196	4051202336202
	Seat and cover hard plastic, soft-close, quick-release, ebony matt black	9M09S133	232	4065467166078
	Seat and cover hard plastic, soft-close, quick-release, matt black	9M09S138	232	4065467445319
	Seat and cover hard plastic, soft-close, quick-release, white	9M09S101	156	4051202251628
2	Stainless steel hinges	92212261	39	4051202476953
	Soft-close, quick-release hinges	92213061	39	4051202478087
3	Suprafix 3.0 fastening set	92238300	82	4051202749453
	Screws and nuts for Suprafix 3.0	92238200	34	4051202743161
4	Dumper set for soft-close seat and cover	92213300	65	4051202478117
5	Buffer set for seat and cover	92213400	17	4051202205423

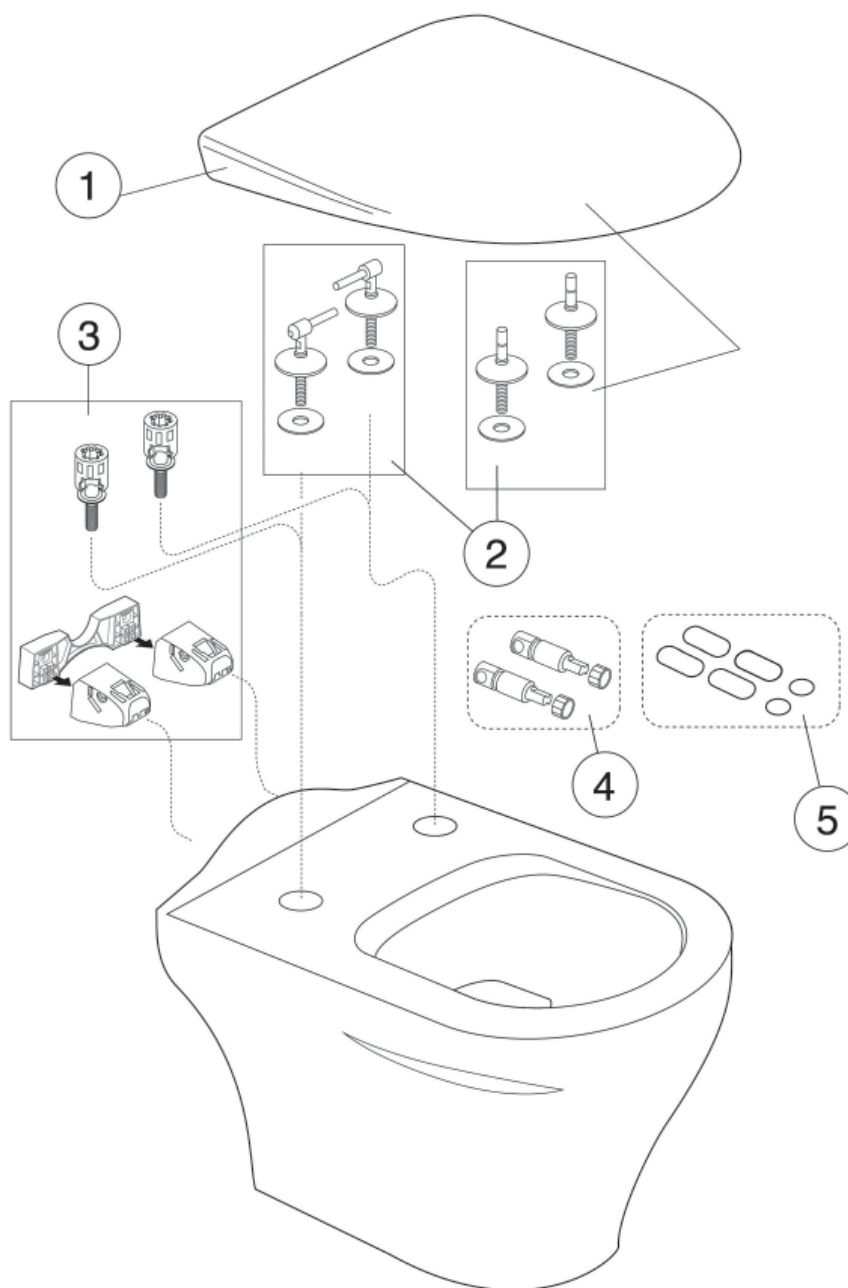

Spare parts for Nautic WC 1530, from 2022-

	ART No.	Price EUR VAT 0%	EAN
1	9M246101	32	4047289920007
Seat and cover Slimseat, soft-close, quick-release, white	8M45S101	116	4062373839379
Seat and cover hard plastic, soft-close, quick-release, white	9M26S101	107	4047289984191
Seat and cover hard plastic, soft-close, quick-release, black	9M26S136	130	4047289984207
Seat and cover hard plastic, stainless steel hinges	9M256101	65	4047289984108
2	92095761	41	4062373896747
Hinges soft-close/quick-release for Slimseat 8M245S101	92096361	40	4062373899823
Stainless steel hinges for 9M256S101 from 2013	92095801	49	4062373908310
3	92242400	64	4051202163105
Wall fixation set	92242001	16	4051202163112
4			
Dumper set for soft-close seat and cover			
5			
Buffer set for seat and cover			

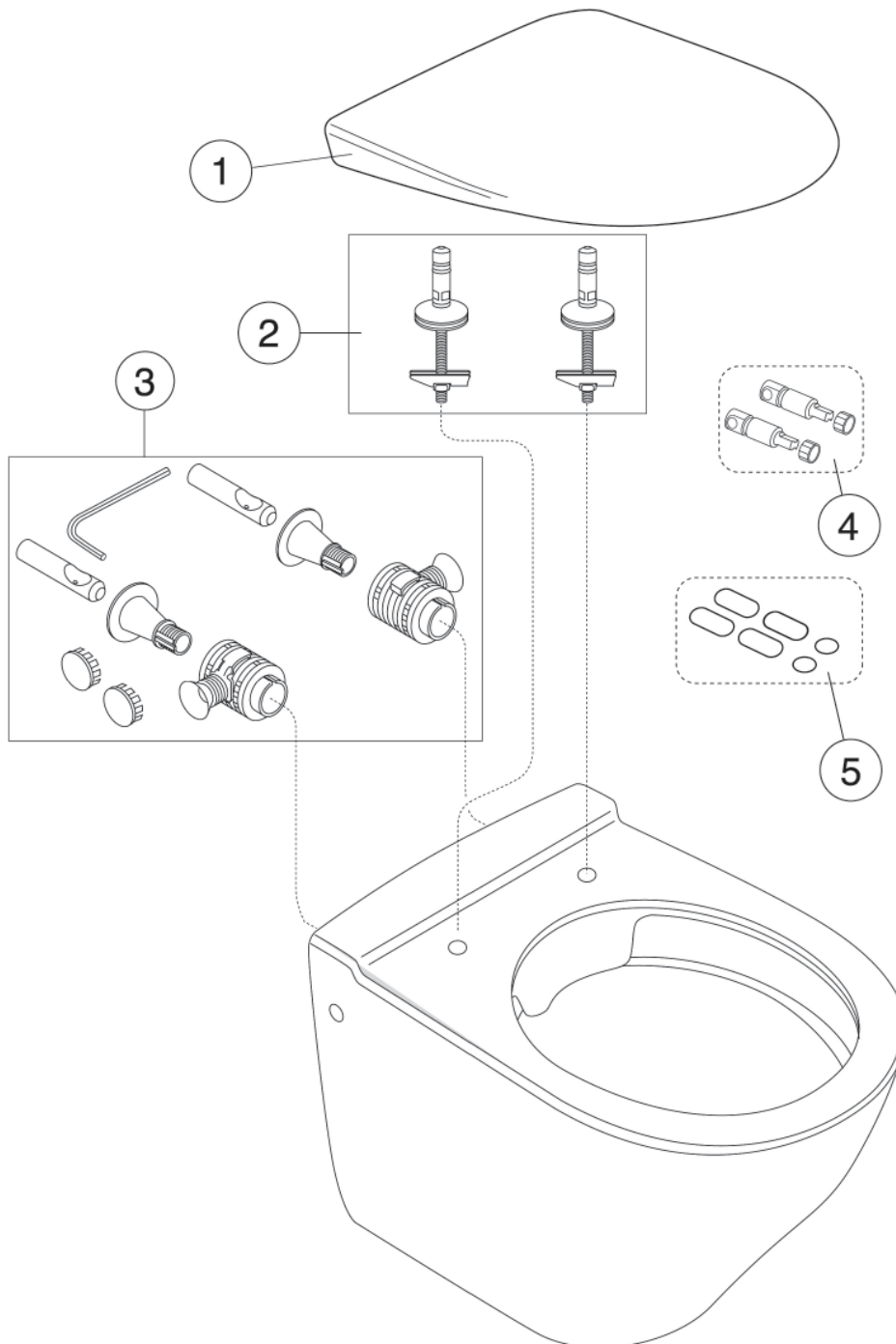

Spare parts for Triomont XS, from 2008 -

		ART No.	Price EUR VAT 0%	EAN
1a	Flush valve Duo/Single, 6/3 L	GB1921100370	34	8711778140981
1b	Flush valve Duo/Single, 4,5/3 L	GB1921100399	42	8711778261112
2	Rubber seal	GB1921100371	18	8711778140882
3	Float valve	GB1921100372	52	8711778140905
4	Rubber membrane	GB1921100373	17	8711778140974
5	Bridging piece Float valve	GB1921100375	18	8711778140998
6	Sleeve for connection tubes 18-28 mm	GB1921100392	19	8711778170995
7	Clamp with control hooks XS	GB1921100377	22	8711778140912
8	Clamp pneumatic control	GB1921100394	67	8711778171015
9	Set fix pins /cont pins Control panel XS/6L Set fix pins /cont pins Control panel/Duo	GB1921100378	21	8711778140943
		GB1921100379	22	8711778140950
10	Masonry aid front XS	GB1921100387	23	8711778141018
11	Wc connetction kit L = 300 mm	GB1921100380	58	8711778140936
12	Flush pipe connector	GB1921100381	37	8711778140875
13	Flushpipe extension 300 mm	GB1921100111	14	7391530070476
14	Discharge elbow 90x90 mm	GB1921100382	34	8711778141049
15	Reducer 90 x110 mm	GB1921100383	28	8711778141056
16	Discharge elbow fixation brachet	GB1921100384	19	8711778141001
17	Flush pipe with tongue XS	GB1921100385	29	8711778141032
18	Rubber seal flush pipe	GB1921100386	21	8711778140899
19	Water connection flexible hose, XS	GB1921100369	99	8711778122901
20	Gasket	GB1921100388	17	7391530064970
21	Repair set flush system Pneumatic hose for push button XS/XT	GB1921100389	67	8711778177369
		GB1921100398	20	8711778169043

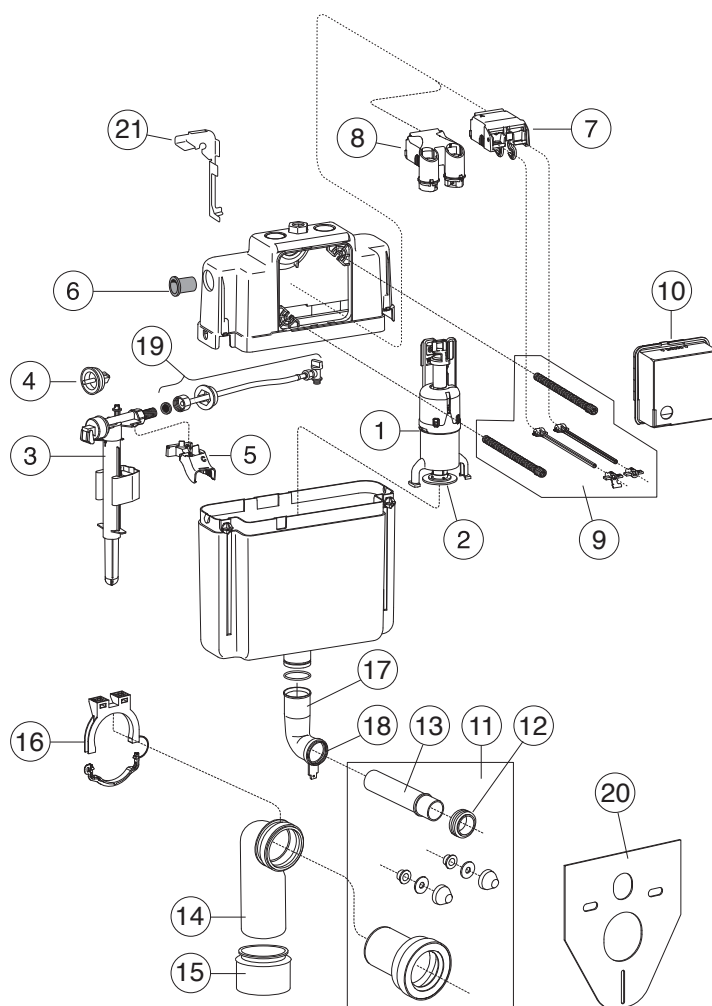

Spare parts for Triomont XT, from 2011 -

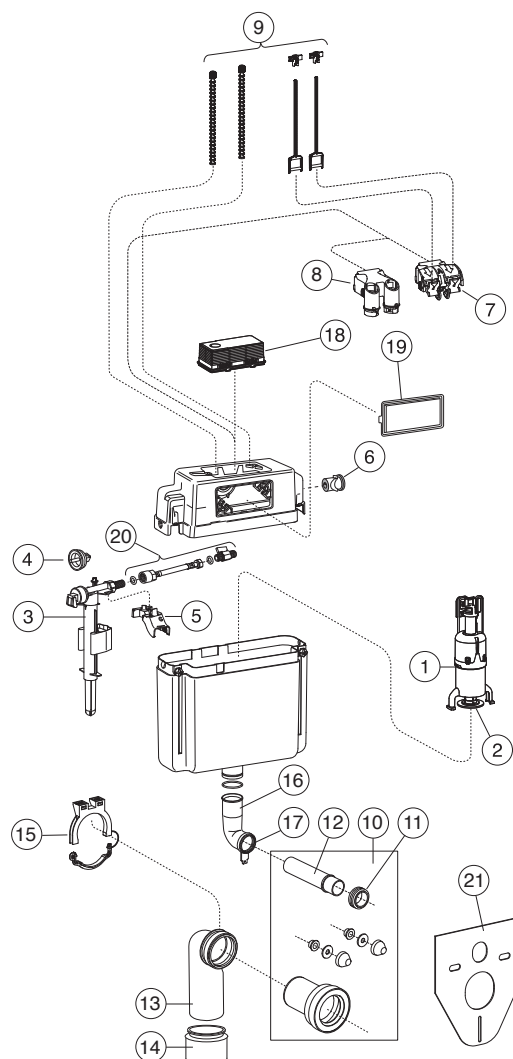

1	Flush valve Duo/Single
2	Rubber seal
3	Float valve
4	Rubber membrane
5	Bridging piece Float valve
6	Sleeve for connection tubes 18-28 mm
7	Clamp with control hooks XT
8	Clamp pneumatic control
9	Set of fixation and control pins for XT
10	Wc connetction kit L = 300 mm
11	Flush pipe connector
12	Flushpipe extension 300 mm
13	Discharge elbow 90x90 mm
14	Reducer 90 x 110 mm
15	Discharge elbow fixation brachet
16	Flush pipe XT 83 cm
17	Rubber seal flush pipe
18	Masonry aid top XT
19	Tank cover plate, XT
20	Water connection flexible hose, XT
21	Gasket
	Pneumatic hose for push button XS/XT

ART No.	Price EUR VAT 0%	EAN
GB1921100370	34	8711778140981
GB1921100371	18	8711778140882
GB1921100372	52	8711778140905
GB1921100373	17	8711778140974
GB1921100375	18	8711778140998
GB1921100392	19	8711778170995
GB1921100395	37	8711778171022
GB1921100394	67	8711778171015
GB1921100391	22	8711778170988
GB1921100380	58	8711778140936
GB1921100381	37	8711778140875
GB1921100111	14	7391530070476
GB1921100382	34	8711778141049
GB1921100383	28	8711778141056
GB1921100384	19	8711778141001
GB1921100397	26	8711778171046
GB1921100386	21	8711778140899
GB1921100390	22	8711778170971
GB1921100396	19	8711778171039
GB1921100393	61	8711778171008
GB1921100388	17	7391530064970
GB1921100398	20	8711778169043

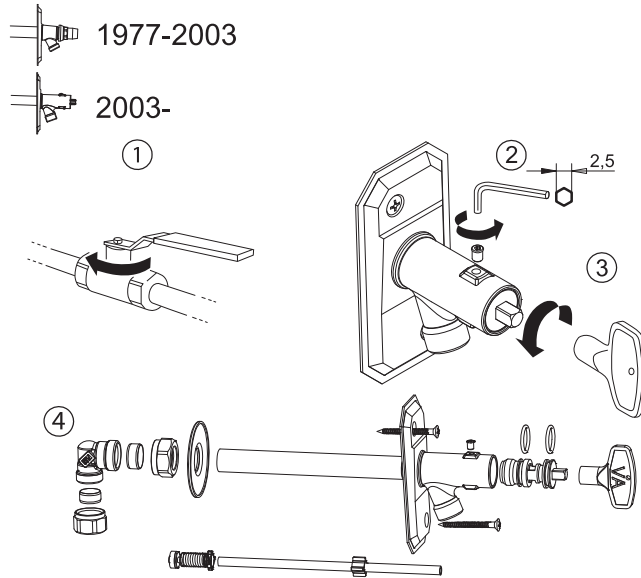

Detail number	Product code	Pcs/package
1	FG0640560	1
2	FG0640835	1
3	FG0640836	1
4	GB41640825	1

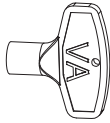
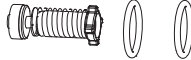
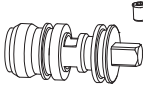
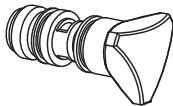
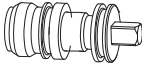
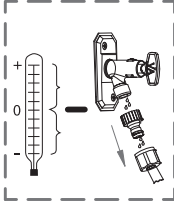
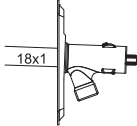

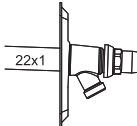
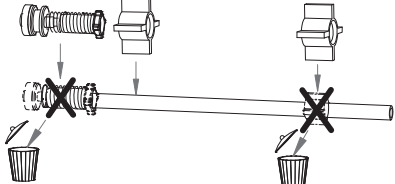
<p>RSK-nr 431 56 10</p> <p>ART-nr FG0640560</p> 	<p>RSK-nr 431 55 16</p> <p>ART-nr FG0640835</p> 
<p>RSK-nr 431 55 18</p> <p>ART-nr FG0640836</p> 	<p>RSK-nr 431 55 23</p> <p>ART-nr FG0640841</p> 
<p>RSK-nr 431 55 17</p> <p>ART-nr FG0640837</p> 	
<p>2003-</p> 	<p>Max 400mm: RSK-nr 431 55 84 ART-nr GB41633505 01</p> <p>Max 600mm: RSK-nr 431 55 30 ART-nr GB41633507 01</p> <p>Max 1000mm: RSK-nr 431 55 83 ART-nr GB41633506 01</p> 
<p>1977-2003</p> 	

Warranty conditions

Warranty conditions

Warranty for Gustavsberg's products is valid from the date of purchase and warranty covers defects in a product caused by defects in design, material or workmanship which occur:

- mixers - within five (5) years of purchase. The warranty applies to defects that cause the mixer to drip (leak) when the lever is in the closed position;
- toilet mechanisms, fixtures, seats, bathtubs, showers, showers walls/doors, accessories, outdoor faucets, fittings and furniture - within two (2) years of purchase;
- ceramics within five (5) years from purchase.

A receipt or invoice must be kept to verify the date of purchase of the product. Please carefully check the product at the point of purchase and follow the installation, operation and maintenance rules. Properly installed and maintained, the product ensures its longevity. Products with visible quality defects may not be mounted or installed. The warranty applies only to genuine Gustavsberg parts.

The warranty does not cover defects caused by incorrect or incomplete installation, maintenance, use, repair or any other external cause of the product after the product has been delivered. The warranty does not cover defects in water quality, normal wear and tear and depreciation. Gustavsberg is not responsible for the suitability of the products for the functions requested by the buyer.

Complaint notification

The Buyer (Customer) must report the defect immediately after it has occurred and must provide a receipt/invoice for the product showing the date of purchase.

Detailed complaint notification information is available on Gustavsberg web-sites:

Estonia <https://www.gustavsberg.com/ee/tugi/garantii-ja-reklamatsioonid/>

Latvia <https://www.gustavsberg.com/lv/palidziba/garantija-un-serviss/>

Lithuania <https://www.gustavsberg.com/lt/prieziurairaptarnavimas/garantinis-aptarnavimas/>

Think Gustavsberg

FOR THE ENVIRONMENT

Our products start saving water and energy as soon as you install them in your bathroom, but our work to boost sustainability starts as early as the production phase: Gustavsberg sells environmentally certified and -declared products, and complies with the LEED, BREEAM and *Miljöbyggnad* (Green Building) environmental assessment systems, as well as with the EU Taxonomy. Our operations are ISO certified in the fields of quality, the environment, energy and working environment.

FOR YOUR FINANCES

A Gustavsberg bathroom is an investment in top quality, durable material, smart functions and timeless Scandinavian design that will last for years and years. And all the time you are enjoying the sweet and simple life in the bathroom, our products are saving water, energy and money.

FOR THE QUALITY

A bathroom has to last for years and years. This applies not only to the products' material and function, but also to their design. Your bathroom needs to be enduringly inviting, refreshing and attractive. A quick tip: As all the components that make up your bathroom are exposed to the same wear and tear, it is essential that all the products you choose maintain equally high quality.

FOR THE SMART FUNCTIONS

As you read this brochure, you will encounter numerous symbols for the smart functions our products contain. These functions perform many different roles, but a trait they all share is that they make your life in the bathroom even simpler and even more enjoyable.

FOR SERVICE AND SPARE PARTS

Gustavsberg's unique spare parts policy guarantees that parts for your product will still be available for ten years after we have stopped making it.

If anything should go wrong in your bathroom, visit our website at gustavsberg.com and watch our instruction videos to help you pinpoint the problem.

BECAUSE OF THE BROAD COLLECTION

We have developed our products to cover requirements in every imaginable kind of bathroom, including public bathrooms and bathrooms in care environments. Consistent high quality, timeless Scandinavian design and a pared-down design idiom makes it simple to combine them all.

FOR THE SIMPLEST, SWEETEST LIFE IN THE BATHROOM

Ever since 1825, Gustavsberg has been a solid part of the community and played a key role in people's hygiene, well-being and life quality. Today, we are a complete supplier of bathroom products and of the simplest, sweetest life in the bathroom – now and in the future.



Welcome to gustavsberg.com!

BE INSPIRED

Visit our website for additional inspiration and to find our complete range for the bathroom.

SUPPORT AND SERVICE

Our website also contains manuals and instruction videos, as well as tips and hints to help you use and care for your Gustavsberg products.

Tallinn
F. R. Faehlmanni 6 • 10125 Tallinn, Eesti
Telefon: +372 646 0312
www.gustavsberg.ee

Rīga
R. Hirša iela 1, 303. office • LV-1045 Rīga, Latvija
Tālrunis: +371 26483443
www.gustavsberg.lv

Vilnius
Polocko 28B-1 • LT-01205 Vilnius, Lietuva
Telefonas: +370 5246 0810
www.gustavsberg.lt

